

INCH-POUND
RR-W-410E
7 February 2002
SUPERSEDING
RR-W-410D
25 April 1984

FEDERAL SPECIFICATION

WIRE ROPE AND STRAND

The General Services Administration has authorized the use of this federal specification by all federal agencies.

1. SCOPE AND CLASSIFICATION

1.1 Scope. This specification covers wire ropes and wire seizing strands (see 6.1). This specification does not include all types, classes, constructions, and sizes of wire rope and strand that are commercially available, but it is intended to cover the more common types, classes, constructions, and sizes that are suitable for federal government use.

1.2 Classification.

1.2.1 Types, classes, constructions, and sizes. Wire ropes and wire seizing strands covered by this specification shall be of the following types, classes, constructions, and sizes as specified (see 6.2(b) and tables L and LI). For general rules for selection of wire rope and strand see 6.3 and tables L and LI. For wire rope and strand definitions and terms, see 6.4.

Type I - General purpose wire ropes

Class 1 - 6 by 7

Class 2 - 6 by 19

Construction 1 - 6 by 19 (2 operations)

Construction 2 - 6 by 19 Warrington

Construction 3 - 6 by 19 Seale

Construction 4 - 6 by 19 Filler wire

Construction 5 - 6 by 19 Warrington-Seale

Beneficial comments, recommendations, additions, deletions, clarifications, etc. and any data that may improve this document should be sent to: Defense Supply Center Richmond, ATTN: DSCR-VBD, 8000 Jefferson Davis Highway, Richmond, VA 23297-5610 by using the self-addressed Standardization Document Improvement Proposal (DD Form 1426) appearing at the end of this document or by letter.

AMSC N/A

FSC 4010

DISTRIBUTION STATEMENT A. Approved for public release; distribution is unlimited.

RR-W-410E

Class 3 - 6 by 37

- Construction 1 - 6 by 37 (3 operations)
- Construction 2 - 6 by 37 (2 operations)
- Construction 3 - 6 by 37 Seale (2 operations)
- Construction 4 - 6 by 37 Filler wire
- Construction 5 - 6 by 37 Seale-Warrington
- Construction 6 - 6 by 37 Warrington-Seale
- Construction 7 - 6 by 37 Seale-Filler wire
- Construction 8 - 6 by 37 Filler wire-Seale
- Construction 9 - 6 by 37 Seale-Warrington-Seale

Class 4 - 8 by 19

- Construction 1 - 8 by 19 (2 operations)
- Construction 2 - 8 by 19 Warrington
- Construction 3 - 8 by 19 Seale
- Construction 4 - 8 by 19 Filler wire
- Construction 5 - 8 by 19 Warrington-Seale

Class 5 - 6 by 61

- Construction 1 - 6 by 61 (3 operations)
- Construction 2 - 6 by 61 (2 operations)
- Construction 3 - 6 by 61 (2 operations)
- Construction 4 - 6 by 61 Filler wire-Seale
- Construction 5 - 6 by 61 Seale-Warrington-Seale
- Construction 6 - 6 by 61 Seale-Filler wire-Seale

Class 6 - 6 by 91

- Construction 1 - 6 by 91 (4 operations)
- Construction 2 - 6 by 91 (3 operations)
- Construction 3 - 6 by 91 (3 operations)
- Construction 4 - 6 by 91 (2 operations)

Type II - Elevator

Class 1 - 6 by 19

- Construction 1 - 6 by 19 Warrington
- Construction 2 - 6 by 19 Filler wire
- Construction 3 - 6 by 19 Warrington-Seale

Class 2 - 8 by 19

- Construction 1 - 8 by 19 (2 operations)
- Construction 2 - 8 by 19 Warrington
- Construction 3 - 8 by 19 Seale
- Construction 4 - 8 by 19 Filler wire
- Construction 5 - 8 by 19 Warrington-Seale

Type III - Marine (cables)

Class 1 - 6 by 6 deck lashing ropes

Class 2 - 6 by 12 running ropes

Class 3 - 6 by 24 mooring lines

- Construction 1 - 6 by 24 (2 operations)
- Construction 2 - 6 by 24 Warrington
- Construction 3 - 6 by 24 Seale

- Class 4 - 6 by 3 by 7 spring lay
- Class 5 - 6 by 3 by 19 spring lay
 - Construction 1 - 6 by 3 by 19 (2 operations)
 - Construction 2 - 6 by 3 by 19 Warrington
 - Construction 3 - 6 by 3 by 19 Seale
- Class 6 - 6 by 42 tiller or hand control ropes
- Type IV- Miscellaneous
 - Class 1 - 5 by 19 marline-clad
 - Construction 1 - 5 by 19 (2 operations)
 - Construction 2 - 5 by 19 Warrington
 - Construction 3 - 5 by 19 Filler wire
 - Class 2 - 18 by 7 rotation resistant
 - Class 3 - flattened strand
 - Construction 1 - 6 by 25 style B
 - Construction 2 - 6 by 30 style G
 - Construction 3 - 6 by 27 style H
 - Construction 4 - 6 by 31 style V
 - Class 4 - 8 by 19 rotation resistant
 - Construction 1 - 8 by 19 Seale
 - Construction 2 - 8 by 19 Filler wire
 - Construction 3 - 8 by 19 Warrington-Seale
- Type V - Auxiliary wire strands
 - Class 1 - 1 by 7 seizing strand
 - Class 2 - 1 by 19 seizing strand (2 operations)
- Type VI- Small cords
 - Class 1 - 3 by 7
 - Class 2 - 7 by 7 (6 by 7 wire strand core)
 - Class 3 - 7 by 19 (6 by 19 wire strand core) (2 operations)

2. APPLICABLE DOCUMENTS

2.1 Government publications. The issues of the following documents, in effect on the date of invitation for bids or request for proposal, form a part of this specification to the extent specified herein.

Federal Specification

PPP-B-1055 - Barrier Material, Waterproofed, Flexible.

Federal Standard

FED-STD-123 - Marking for Shipment (Civil Agencies).

(Activities outside the federal government may obtain copies of federal specifications, standards, and commercial item descriptions as specified in the General Information section of

the Index of Federal Specifications, Standards and Commercial Item Descriptions. The index is for sale on a subscription basis from the General Services Administration, Federal Supply Service, Specification Section, East 470 L'Enfant Plaza SW, Suite 8100, Washington, DC 20407.)

(Single copies of this specification, and other federal specifications and commercial item descriptions required by activities outside the federal government for bidding purposes are available without charge from the General Services Administration, Federal Supply Service, Specification Section, East 470 L'Enfant Plaza SW, Suite 8100, Washington, DC 20407.)

(Federal government activities may obtain copies of federal standardization documents and the Index of Federal Specifications, Standards, and Commercial Item Descriptions from established distribution points in their agencies.)

Military Specifications

- | | |
|---------------|--|
| MIL-DTL-83420 | - Wire Rope, Flexible, for Aircraft Control. |
| MIL-P-24216 | - Polypropylene Cores, Strand Centers, and Substrands for Wire Rope. |
| MIL-PRF-16173 | - Corrosion Preventive Compound, Solvent Cutback, Cold-Application. |

(Copies of military specifications and standards required by contractors in connection with specific procurement functions are obtained from the Standardization Document Order Desk, Building 4D, 700 Robbins Avenue, Philadelphia, PA 1911-5094. Electronic copies of specifications and standards may be obtained from <http://astimage.daps.dla/quicksearch/>.)

2.2 Other publications. The following documents form a part of this specification to the extent specified herein. Unless a specific issue is identified, the issue in effect on the date of invitation for bids or request for proposal shall apply.

American Hardboard Association (AHBA)

- | | |
|-----------------|----------------------------------|
| ANSI/AHA A135.4 | - Basic Hardboard (DoD adopted). |
|-----------------|----------------------------------|

(Private sector and civil agencies may purchase copies of these voluntary standards from the American Hardboard Association, 1210 West Northwest Highway, Palatine, IL 60067-1897.)

American Society For Testing and Materials (ASTM)

- | | |
|-------------------|---|
| ASTM A 700 | - Standard Practice for Packaging, Marking, and Loading Methods for Steel Products for Domestic Shipment (DoD adopted). |
| ASTM B 139/B 139M | - Standard Specification for Phosphor Bronze Rod, Bar, and Shapes (DoD adopted). |
| ASTM D 3953 | - Standard Specification for Strapping, Flat Steel and Seals (DoD adopted). |

- | | |
|---------------------|---|
| ASTM D 6039/D 6039M | - Standard Specification for Crates, Wood, Open and Covered (DoD adopted). |
| ASTM E 8 | - Standard Test Methods for Tension Testing of Metallic Materials (DoD adopted). |
| ASTM E 8M | - Standard Test Methods for Tension Testing of Metallic Materials [Metric] (DoD adopted). |

(Private sector and civil agencies may purchase copies of these voluntary standards from the American Society for Testing and Materials, 100 Barr Harbor Drive, West Conshohocken, PA 19428-2959. Electronic copies may be obtained from <http://www.astm.org/>.)

Society of Automotive Engineers (SAE)

- | | |
|----------------|--|
| SAE AMS-STD-66 | - Steel: Chemical Composition and Hardenability (DoD adopted). |
|----------------|--|

(Private sector and civil agencies may purchase copies of these voluntary standards from the Society of Automotive Engineers, 400 Commonwealth Drive, Warrendale, PA 15096-0001. Electronic copies may be obtained from <http://www.sae.org/>.)

National Motor Freight Traffic Association, Inc.

National Motor Freight Classification

(Private sector and civil agencies may purchase copies of these voluntary standards from the National Motor Freight Traffic Association, Inc., 2200 Mill Road, Alexandria, VA 22314.)

Surface Transportation Board

- | | |
|--------------|--|
| WRA UFC 6000 | - Uniform Freight Classification - Ratings, Rules and Regulations. |
|--------------|--|

(Private sector and civil agencies may purchase copies of these voluntary standards from the Surface Transportation Board, 1925 K Street NW, Washington, DC 20423-0001.)

3. REQUIREMENTS

3.1 Material. Wire rope and strand shall be made of iron, annealed steel, traction steel, improved plow steel, extra improved plow steel, phosphor bronze, or corrosion-resistant steel as specified in the detail requirements for the individual wire ropes and strands.

3.1.1 Iron, annealed steel, traction steel, improved plow steel, and extra improved plow steel.

Material shall be free from defects that are detrimental to its appearance or serviceability. Steel for wires shall be made by either the open-hearth, basic oxygen, or electric furnace process.

3.1.2 Phosphor bronze. Unless otherwise specified (see 6.2(c)), phosphor bronze shall be in accordance with composition A of ASTM B 139/B 139M.

3.1.3 Corrosion-resistant steel. Corrosion-resistant steel wire ropes shall be made of wires of 302 or 304 composition as specified in SAE AMS-STD-66.

3.1.4 Recovered materials. The offeror/contactor is encouraged to use recovered materials to the maximum extent practicable, in accordance with paragraph 23.403 of the Federal Acquisition Regulation (FAR).

3.2 Wire rope cores and centers for wire strands. Wire rope cores and centers for wire strands shall be as specified in 3.2.1 through 3.2.5 for the individual wire ropes and strand centers.

3.2.1 Fiber core (see figure 1). Fiber core for wire rope shall be one of the hard fibers or polypropylene fiber. The hard fibers are manila (abaca) and sisal (African, Java, Mauritius, Mexican, and Yucatan). Cotton, hemp, or jute fibers, hard laid, may be used in wire rope cores in fiber sizes of 1/8 inch in diameter and smaller. A mixture of two or more species of hard fibers may be used. Polypropylene fibers shall meet the requirements of MIL-P-24216. Fiber cores of wire ropes shall be thoroughly cleaned, free from waste, evenly twisted, and of uniform ply.

3.2.2 Wire strand core (see figure 2). The numbers of wires in the wire strand core shall be not less than the number of wires in the strands of the wire rope. Wires in the wire strand core shall be of the same material, or of a lower tensile strength steel (see table I), as the wires in the strands of the wire rope. Iron or annealed steel shall not be used.

3.2.3 Independent wire rope core (IWRC) (see figure 3). IWRC may be a 6 by 7 wire rope with either a fibrous or wire strand (making it a 7 by 7) core. Six by 61 (type I, general purpose, class 5) and 6 by 91 (type I, general purpose, class 6) wire rope shall have 19 wire strands instead of 7 wire strands (making it a 7 by 19) in the IWRC. Wire rope with an independent wire rope core shall carry the letters IWRC in its description or designation. Wires in the IWRC shall be of the same material, or of a lower tensile strength steel (see table I), as the wires in the strands of the wire rope. Iron or annealed steel shall not be used.

3.2.4 Centers for wire strands. Centers in wire strands shall be either of a twisted fibrous material, or a single wire as outlined in the specific strand construction description. When this wire becomes so large (manufacturer's discretion) that it is considered undesirable, a 7 wire strand is allowed to replace it, as specified (see 6.2(d)). This 7 wire strand center shall not increase the number of stranding operations of the main strand or the number of wires in the main strand wire count. Fiber centers for wire strands shall be as specified in 3.2.1.

3.2.5 Other material for cores and centers. When specified (see 6.2(e)), glass fibers, plastic fibers, twisted and waxed kraft paper, spiral springs, or flexible plastic rods may be used in wire rope cores and wire strand centers.

3.3 Mechanical properties (see 3.9).

3.3.1 Tensile strength.

3.3.1.1 Wire ropes. Wire ropes covered in this specification shall meet or exceed the acceptance breaking strength requirements specified in the applicable table.

3.3.1.2 Main wires (load carrying). Where applicable, main wires in the main stands shall conform with the tensile strength requirements shown in table I.

3.3.1.3 Drawn galvanized wires. When drawn galvanized wire is ordered it shall conform to the tensile requirements for bright (uncoated) steel wire shown in table I. The weight of zinc coating shall conform to the requirements shown in table II.

3.3.2 Torsion strength. Where applicable, main wires in the main strands, either bright (uncoated) or drawn galvanized, shall conform to the minimum torsion requirements shown in table III.

3.3.3 Wrapping.

3.3.3.1 Rope wires of iron and steel grades, zinc coated (galvanized) at finished size. Rope wires of iron and steel grades, zinc coated at finished size, shall withstand wrapping in a close helix for six complete turns around a mandrel, followed by unwrapping without breakage or fracture of the wire. For zinc coated iron wires, the mandrel shall be the same diameter as the wire. For zinc coated steel wires, the mandrel shall be two times the diameter of the wire.

3.3.3.2 Rope wires of uncoated iron and phosphor bronze. Rope wires of uncoated iron and phosphor bronze shall withstand wrapping in a close helix for six complete turns around a mandrel having a diameter the same as the wire.

3.3.4 Pre-stretched (pre-stressed) wire rope. When specified (see 6.2(f)), the wire rope shall be pre-stretched. The wire rope shall be subjected to 3 cycles of tensile loading of the wire rope to 40 percent of the nominal strength for 5 minutes and returning the tensile load to 5 percent of the nominal strength between cycles. After the last cycle, the tensile load shall be completely released.

3.3.5 Finish.

3.3.5.1 Uncoated carbon steel. Unless otherwise specified (see 6.2(g)), wire ropes shall be uncoated carbon steel.

3.3.5.2 Zinc coating (galvanized). When specified (see 6.2(h)), zinc coating shall be applied by either the electrolytic plating process or by hot dipping in molten zinc. The weight of the zinc coating shall be as specified in table II.

3.3.5.2.1 The zinc coating shall be free from uncoated spots, lumps, pits, blisters, gritty areas, dross, and flux.

3.4 Fabrication.

3.4.1 Wire rope. A wire rope shall consist of a specified number of wire strands closed around a core. Each strand shall be constructed as specified in the detail requirements for the individual class and construction.

3.4.1.1 Rope and strand wires. Wires in the same layer of wire ropes and strands shall be considered of one diameter when the difference between the largest and the smallest diameters does not exceed the values shown in table IV.

3.4.2 Wire joints. Wires up to and including 0.014 inch in diameter may be spliced by twisting. Wires larger than 0.014 inch in diameter shall be joined by lap brazing or butt welding. Butt welds shall be annealed.

3.4.2.1 Twisted splices of wires of any one layer of a strand shall not be closer than 20 feet. Brazed or butt-welded joints in the wires of a strand shall not be closer than 18 inches.

3.4.3 Preformed and non-preformed wire ropes and stands. Unless otherwise specified (see 6.2(i)), the contractor shall supply either preformed or non-preformed wire ropes and strands as specified in 3.4.3.1 and 3.4.3.2.

3.4.3.1 Preformed wire ropes and strands. Wire ropes in which the strands and their wires are permanently shaped during fabrication to a spiral form they assume in the finished wire rope or strand shall be identified as preformed wire ropes or strands.

3.4.3.2 Non-preformed wire ropes and strands. Wire ropes in which the strands and their wires are not permanently shaped during fabrication to a spiral form they assume in the finished wire rope or strand shall be identified as non-preformed wire ropes or strands.

3.4.4 Lays (see figure 4). Wire rope lays shall be as specified in the detail requirements for the individual wire ropes and strands.

3.4.4.1 Right regular lay. Wires in the strand are laid to the left, and strands in the rope are laid to the right.

3.4.4.2 Left regular lay. Wires in the strand are laid to the right, and strands in the rope are laid to the left.

3.4.4.3 Right lang lay. Both the wires in the strand and the strands in the rope are laid to the right.

3.4.4.4 Left lang lay. Both the wires in the strand and the strands in the rope are laid to the left.

3.4.4.5 Strand pitch. Strands in wire ropes shall have a pitch of not less than 5 1/2 times the nominal rope diameter. The maximum pitch shall be not more than specified in the applicable table. Three strand ropes shall have a pitch of not less than 4 1/2 times the nominal rope diameter.

3.5 Construction. Unless otherwise specified (see 6.2(j)), the contractor may supply wire rope and strand of any construction applicable to the size rope or strand being furnished.

3.6 Lubrication.

3.6.1 Iron or traction steel wire rope for elevator service. Wires of iron or traction steel wire rope for elevator service shall be thoroughly coated with lubricant during the process of manufacture. The lubrication shall be compounded for each specific application so as not to restrict the rope's operating characteristics.

3.6.2 Uncoated iron or steel wire ropes. Unless otherwise specified, wires of uncoated (not galvanized) iron or steel wire ropes shall be thoroughly coated with a lubricant during the process of manufacture. The lubricant shall be petroleum oil based and compounded with additives to provide lubrication qualities and maximum corrosion protection during shipping, storage, handling, and the initial period of service and to provide a suitable lubricant base for subsequent field re-lubrications. The pour point of the lubricant shall be above 100 °F making the lubricant a semi-solid at room temperature. The lubricant should be heated to a fluid state before applying to the wires and laying the rope. The flash point of the lubricant shall be above 400 °F. The lubricant shall be free of substances injurious to steel wires and fiber cores.

3.6.2.1 For particular applications, iron or steel wire ropes may be required to have a special lubricant other than the lubricant specified in 3.6.2 (see 6.2(k)).

3.6.2.2 When it is specified that no lubrication be applied to iron or steel wire ropes (see 6.2(k)), a corrosion inhibitor conforming to MIL-PRF-16173, grade 1, shall be applied to the entire length of the wire rope after closure to prevent corrosion prior to installation, unless otherwise specified (see 6.2(l)).

3.6.3 Coated (galvanized) steel and iron, corrosion-resistant steel, and phosphor bronze wire ropes. Unless otherwise specified (see 6.2(m)), coated (galvanized) steel and iron, corrosion-resistant steel, and phosphor bronze wire ropes may be lightly lubricated during fabrication.

3.6.3.1 Coated (galvanized) steel ropes. Coated (galvanized) steel ropes that are to be immersed in sea water shall be lubricated in accordance with 3.6.2.

3.6.4 Fiber centers and cores. Fiber centers and cores shall be thoroughly impregnated during fabrication with a lubricant which shall contain preservative materials to allay deterioration of fiber parts due to rot or mildew and shall not be injurious to the steel wires. This requirement is not applicable to polypropylene cores or centers.

3.6.5 Wire strand core and IWRC. Wire strand core and IWRC shall be thoroughly covered with a lubricant for protecting and preserving their wires.

3.7 Diameter of wire rope and strands. Except for type II elevator, type III spring lay, type IV marline clad, type V seizing strand, and type VI small cord, which are of special construction, the actual diameter of wire ropes and strands shall not differ from the ordered diameter by more than the amounts shown in tables V and VI.

3.7.1 Traction steel and iron elevator rope. The maximum diameter tolerance based on nominal rope diameter shall be as shown in the maximum (no load) column of the applicable table. With a load of 10 percent of minimum breaking strength, the minimum diameter tolerance based on nominal rope diameter shall be plus 1/128 inch.

3.8 Seizing. Each end of each length of wire rope shall be suitably seized.

3.9 Mechanical properties. Mechanical properties for wire in ropes and strands shall be as specified in tables I and III, except for filler wires, non-round wires, wires in wire strand cores, and wires in IWRCs (see 3.2.2 and 3.2.3).

3.10 Workmanship. Wire ropes shall be uniform in material and quality and shall be securely laid and free from kinks, loose wires, loose strands, or other defects that may be detrimental to their serviceability and appearance.

3.11 Type I, general purpose.

3.11.1 Type I, general purpose, class 1, 6 by 7 (see figure 5). Wire rope shall have 6 strands of 7 wires totaling 42 wires, laid around a fiber core as specified (see 3.11.1.3).

3.11.1.1 Each strand shall have 1 wire center and 6 outer wires. Wires in the outer layer shall be of one diameter. Each strand shall be fabricated in one operation.

3.11.1.2 Material. Material shall be of improved plow steel or iron, as specified (see 3.1 and 6.2(n-1)).

3.11.1.2.1 Finish. Wire ropes of iron shall be of zinc coated (galvanized) wires, and unless a zinc coating material is specified (see 3.3.5 and 6.2(n-2)), improved plow steel shall be of uncoated (bright) wires.

3.11.1.3 Cores. Cores shall be of fiber as specified (see 3.2.1, 3.2.5 and 6.2(n-3)).

3.11.1.4 Fabrication. Wire ropes shall be fabricated as specified (see 3.4 and 6.2(n-4)).

3.11.1.5 Lay. Unless otherwise specified (see 6.2(n-5)), wire ropes shall be supplied with right regular lay (see 3.4.4.1).

3.11.1.6 Dimensions, weight, and strength. Dimensions, weight, and strength requirements shall be as specified in tables VII and VIII.

3.11.2 Type I, general purpose, class 2, 6 by 19.

3.11.2.1 Material. Material shall be of improved plow steel, extra improved plow steel, corrosion-resistant steel, or phosphor bronze as specified (see 3.1 and 6.2(o-1)).

3.11.2.1.1 Finish. Wire rope of phosphor bronze and corrosion-resistant steel shall be of uncoated (bright) wires. Wire rope of improved plow steel or extra improved plow steel shall be of uncoated (bright) or zinc coated (drawn galvanized) wires as specified (see 3.3.1.3, 3.3.5, and 6.2(o-2)).

3.11.2.1.2 Cores. Cores shall be in accordance with table IX as specified (see 6.2(0-3)).

3.11.2.1.3 Fabrication. Wire ropes shall be fabricated as specified (see 3.4 and 6.2(o-4)).

3.11.2.1.4 Lay. Wire ropes with fiber cores shall be supplied with right regular lay unless otherwise specified (see 3.4.4.1 and 6.2(o-5)).

3.11.2.1.5 Dimensions, weight, and strength. Dimensions, weight, and strength requirements shall be as specified in tables X and XIV.

3.11.2.2 Type I, general purpose, class 2, construction 1, 6 by 19 (2 operations) (see figure 6). Wire ropes shall have 6 strands of 19 wires each, totaling 114 wires in the strands. This construction shall not be required in lang lay or in sizes larger than 3/8 inch.

3.11.2.2.1 Each strand shall have 1 wire center, 6 inner wires, and 12 outer wires. Wires in the inner layer shall be of one diameter. Wires in the outer layer shall be of one diameter. Each strand shall be fabricated in two operations.

3.11.2.3 Type I, general purpose, class 2, construction 2, 6 by 19 (Warrington) (see figure 7). Wire ropes shall have 6 strands of 19 wires each, totaling 114 wires in the strands. This construction shall not be required in lang lay.

3.11.2.3.1 Each strand shall have 1 center wire, 6 inner wires, and 12 outer wires. Wires in the inner layer shall be of one diameter. Wires in the outer layer shall be of two diameters of wire laid alternately. Each strand shall be fabricated in one operation.

3.11.2.4 Type I, general purpose, class 2, construction 3, 6 by 19 (Seale) (see figure 8). Wire ropes shall have 6 strands of 19 wires each, totaling 114 wires in the strands.

3.11.2.4.1 Each strand shall have 1 center wire, 9 inner wires, and 9 outer wires. Wires in the inner layer shall be of one diameter. Wires in the outer layer shall be of one diameter. Each strand shall be fabricated in one operation.

3.11.2.5 Type I, general purpose, class 2, construction 4, 6 by 19 (Filler wire) (see figure 9). Wire ropes shall have 6 strands of not less than 21 wires and not more than 25 wires each, totaling not less than 126 nor more than 150 wires in the strands. This construction shall not be required in sizes smaller than 3/8 inch.

3.11.2.5.1 Each strand shall have 1 wire center, not less than 5 nor more than 6 inner wires, and not less than 10 nor more than 12 outer wires. There shall be not less than 5 nor more than 6 wires (fillers) between the layers. Wires in the inner layer shall be of one diameter. Wires in the outer layer shall be of one diameter. Filler wires shall be of one diameter. Each strand shall be fabricated in one operation.

3.11.2.6 Type I, general purpose, class 2, construction 5, 6 by 19 (Warrington-Seale) (see figure 10). Wire ropes shall have 1 core and 6 strands of 26 wires each, totaling 156 wires in the strands.

3.11.2.6.1 Each strand shall have 1 center wire, 5 inner wires, 10 intermediate wires, and 10 outer wires. Wires in the inner layer shall be of one diameter. Wires in the intermediate layer shall be of two diameters of wire laid alternately. Wires in the outer layer shall be of one diameter. Each strand shall be fabricated in one operation.

3.11.3 Type I, general purpose, class 3, 6 by 37.

3.11.3.1 Material. Material shall be of improved plow steel, extra improved plow steel, or corrosion-resistant steel as specified (see 3.1 and 6.2(p-1)).

3.11.3.1.1 Finish. Wire rope of corrosion-resistant steel shall be of uncoated (bright) wires. Wire rope of improved plow steel or extra improved plow steel shall be of uncoated (bright) or zinc coated (drawn galvanized) wires as specified (see 3.3.5, and 6.2(p-2)).

3.11.3.1.2 Cores. Cores shall be in accordance with table IX as specified (see 6.2(p-3)).

3.11.3.1.3 Fabrication. Wire ropes shall be fabricated as specified (see 3.4 and 6.2(p-4)).

3.11.3.1.4 Lay. Lay shall be as specified (see 3.4.4 and 6.2(p-5)).

3.11.3.1.5 Dimensions, weight, and strength. Dimensions, weight, and strength requirements shall be as specified in tables X through XIII and XV through XVIII.

3.11.3.2 Type I, general purpose, class 3, construction 1, 6 by 37 (3 operations) (see figure 11). Wire ropes shall have 1 core and 6 strands of not less than 34 nor more than 37 wires each, totaling not less than 204 nor more than 222 wires in the strands. This construction shall not be required in lang lay or in sizes larger than 3/8 inch.

3.11.3.2.1 Each strand shall have 1 center wire, 6 inner wires, 12 intermediate wires, and not less than 15 nor more than 18 outer wires. Wires in the inner layer shall be of one diameter. Wires in the intermediate layer shall be of one diameter. Wires in the outer layer shall be of one diameter. Each strand shall be fabricated in three operations.

3.11.3.3 Type I, general purpose, class 3, construction 2, 6 by 37 (2 operations) (see figure 12). Wire ropes shall have 1 core and 6 strands of not less than 33 nor more than 43 wires each, totaling not less than 198 nor more than 258 wires in the strands. This construction shall not be required in lang lay.

3.11.3.3.1 Each strand shall have 1 center strand of 19 to 25 wires constructed in accordance with 3.11.2.3, 3.11.2.4, and 3.11.2.5. Over this center strand, the outer layer shall be not less than 14 nor more than 18 wires. Wires in the outer layer shall be of one diameter. Each strand shall be fabricated in two operations.

3.11.3.4 Type I, general purpose, class 3, construction 3, 6 by 37 (Seale) (2 operations) (see figure 13). Wire ropes shall have 1 core and 6 strands of not less than 27 nor more than 37 wires each, totaling not less than 162 nor more than 222 wires in the strands. This construction is generally furnished only in regular lay. It shall not be required in sizes larger than 1 inch.

3.11.3.4.1 Each strand shall have 1 center wire, 6 inner wires, not less than 10 nor more than 15 intermediate wires, and not less than 10 nor more than 15 outer wires. Wires in the inner layer shall be of one diameter. Wires in the intermediate layer shall be of one diameter. Wires in the outer layer shall be of one diameter. Each strand shall be fabricated in two operations.

3.11.3.5 Type I, general purpose, class 3, construction 4, 6 by 37 (Filler wire) (see figure 14). Wire ropes shall have 1 core and 6 strands of not less than 29 nor more than 37 wires each, totaling not less than 174 nor more than 222 wires in the strands. This construction shall not be required in sizes smaller than 3/8 inch.

3.11.3.5.1 Each strand shall have 1 center wire, not less than 7 nor more than 9 inner wires, and not less than 14 nor more than 18 outer wires. There shall be not less than 7 nor more than 9 filler wires between the inner and outer layers. Wires in the inner layer shall be of one diameter. Wires in the outer layer shall be of one diameter. Filler wires shall be of one diameter. Each strand shall be fabricated in one operation.

3.11.3.6 Type I, general purpose, class 3, construction 5, 6 by 37 (Seale-Warrington) (see figure 15). Wire ropes shall have 1 core and 6 strands of not less than 29 nor more than 37 wires each, totaling not less than 174 nor more than 222 wires in the strands. This construction shall not be required in lang lay or in sizes smaller than 3/8 inch.

3.11.3.6.1 Each strand shall have 1 center wire, not less than 7 nor more than 9 inner wires, not less than 7 nor more than 9 intermediate wires, and not less than 14 nor more than 18 outer wires. Wires in the inner layer shall be of one diameter. Wires in the intermediate layer shall be of one diameter. Wires in the outer layer shall be of two diameters, laid alternately. Each strand shall be fabricated in one operation.

3.11.3.7 Type I, general purpose, class 3, construction 6, 6 by 37 (Warrington-Seale) (see figure 16). Wire ropes shall have 1 core and 6 strands of not less than 31 nor more than 46 wires each, totaling not less than 186 nor more than 276 wires in the strands.

3.11.3.7.1 Each strand shall have 1 center wire, not less than 6 nor more than 9 inner wires, not less than 12 nor more than 18 intermediate wires, and not less than 12 nor more than 18 outer wires. Wires in the inner layer shall be of one diameter. Wires in the intermediate layer shall be of two diameters of wires laid alternately. Wires in the outer layer shall be of one diameter. Each strand shall be fabricated in one operation.

3.11.3.8 Type I, general purpose, class 3, construction 7, 6 by 37 (Seale-Filler wire) (see figure 17). Wire ropes shall have 1 core and 6 strands of not less than 36 nor more than 46 wires each, totaling not less than 216 nor more than 276 wires in the strands. This construction shall not be required in sizes 3/8 inch and smaller.

3.11.3.8.1 Each strand shall have 1 center wire, not less than 7 nor more than 9 inner wires, not less than 7 nor more than 9 intermediate wires, and not less than 14 nor more than 18 outer wires. There shall be not less than 7 nor more than 9 filler wires between the intermediate and outer layers. Wires in the inner layer shall be of one diameter. Wires in the intermediate layer shall be of one diameter. Wires in the outer layer shall be of one diameter. Filler wires shall be of one diameter. Each strand shall be fabricated in one operation.

3.11.3.9 Type I, general purpose, class 3, construction 8, 6 by 37 (Filler wire-Seale) (see figure 18). Wire ropes shall have 1 core and 6 strands of not less than 31 nor more than 49 wires each, totaling not less than 186 nor more than 294 wires in the strands. This construction shall not be required in sizes smaller than 1/2 inch.

3.11.3.9.1 Each strand shall have 1 center wire, not less than 5 nor more than 8 inner wires, not less than 10 nor more than 16 intermediate wires, and not less than 10 nor more than 16 outer wires. There shall be not less than 5 nor more than 8 filler wires between the inner and intermediate layers. Wires in the inner layer shall be of one diameter. Wires in the intermediate layer shall be of one diameter. Wires in the outer layer shall be of one diameter. Filler wires shall be of one diameter. Each strand shall be fabricated in one operation.

3.11.3.10 Type I, general purpose, class 3, construction 9, 6 by 37 (Seale-Warrington-Seale) (see figure 19). Wire ropes shall have 1 core and 6 strands of not less than 43 nor more than 49 wires each, totaling not less than 258 nor more than 294 wires in the strands. This construction shall not be required in sizes smaller than 2 inches.

3.11.3.10.1 Each strand shall have 1 center wire, not less than 7 nor more than 8 inner wires, not less than 7 nor more than 8 inside intermediate wires, not less than 14 nor more than 16 outside intermediate wires, and not less than 14 nor more than 16 outer wires. Wires in the inner layer shall be of one diameter. Wires in the inside intermediate layer shall be of one diameter. Wires in the outside intermediate layer shall be of two diameters, laid alternately. Wires in the outer layer shall be of one diameter. Each strand shall be fabricated in one operation.

3.11.4 Type I, general purpose, class 4, 8 by 19.

3.11.4.1 Material. Material shall be of improved plow steel as specified in 3.1.

3.11.4.1.1 Finish. Wire rope shall be uncoated (bright) or zinc coated (galvanized) wires as specified (see 3.3.5, and 6.2(q-1)).

3.11.4.1.2 Cores. Cores shall be fiber cores in accordance with 3.2.1 or when specified (see 3.2.5 and 6.2(q-2)).

3.11.4.1.3 Fabrication. Wire ropes shall be fabricated as specified (see 3.4 and 6.2(q-3)).

3.11.4.1.4 Lay. Lay shall be right regular lay in accordance with 3.4.4.1.

3.11.4.1.5 Dimensions, weight, and strength. Dimensions, weight, and strength requirements shall be as specified in table XIX.

3.11.4.2 Type I, general purpose, class 4, construction 1, 8 by 19 (2 operations) (see figure 20).

Wire ropes shall have 1 core and 8 strands of 19 wires each, totaling 152 wires in the strands. This construction shall not be required in sizes larger than 1/4 inch.

3.11.4.2.1 Each strand shall be in accordance with 3.11.2.2.1.

3.11.4.3 Type I, general purpose, class 4, construction 2, 8 by 19 (Warrington) (see figure 21).

Wire ropes shall have 1 core and 8 strands of 19 wires each, totaling 152 wires in the strands. This construction shall not be required in sizes smaller than 1/4 inch.

3.11.4.3.1 Each strand shall be in accordance with 3.11.2.3.1.

3.11.4.4 Type I, general purpose, class 4, construction 3, 8 by 19 (Seale) (see figure 22). Wire ropes shall have 1 core and 8 strands of 19 wires each, totaling 152 wires in the strands.

3.11.4.4.1 Each strand shall be in accordance with 3.11.2.4.1.

3.11.4.5 Type I, general purpose, class 4, construction 4, 8 by 19 (Filler wire) (see figure 23).

Wire ropes shall have 1 core and 8 strands of not less than 21 nor more than 25 wires, totaling not less than 168 nor more than 200 wires in the strands. This construction shall not be required in sizes smaller than 7/16 inch.

3.11.4.5.1 Each strand shall be in accordance with 3.11.2.5.1.

3.11.4.6 Type I, general purpose, class 4, construction 5, 8 by 19 (Warrington-Seale) (see figure 24).

Wire ropes shall have 1 core and 8 strands of 26 wires each, totaling 208 wires in the strands.

3.11.4.6.1 Each strand shall be in accordance with 3.11.2.6.1.

3.11.5 Type I, general purpose, class 5, 6 by 61 (see figure 25).

3.11.5.1 Material. Material shall be of improved plow or extra improved plow steel as specified (see 3.1 and 6.2(r-1)).

3.11.5.1.1 Finish. Wire rope of improved plow steel or extra improved plow steel shall be of uncoated (bright) or zinc coated (drawn galvanized) wire as specified (see 3.3.5, and 6.2(r-2)).

3.11.5.1.2 Cores. Wire ropes of improved plow steel shall have either fiber core, wire strand core, or IWRC as specified (see 3.2 and 6.2(r-3)). Wire ropes of extra improved plow steel shall have an IWRC in accordance with 3.2.3.

3.11.5.1.3 Fabrication. Wire ropes shall be fabricated as specified (see 3.4 and 6.2(r-4)).

3.11.5.1.4 Lay. Lay shall be as specified (see 3.4.4 and 6.2(r-5)).

3.11.5.1.5 Dimensions, weight, and strength. Dimensions, weight, and strength requirements shall be as specified in tables XX, XXI, and XXII.

3.11.5.2 Type I, general purpose, class 5, construction 1, 6 by 61 (3 operations). Wire ropes shall have 1 core and 6 strands of not less than 53 nor more than 68 wires each, totaling not less than 318 nor more than 408 wires in the strands. This construction is not furnished in lang lay and it is not furnished preformed. This construction shall not be required in sizes smaller than 2 inches.

3.11.5.2.1 Each strand shall have 1 center strand of 19 to 26 wires constructed in accordance with 3.11.2.3.1, 3.11.2.4.1, 3.11.2.5.1, or 3.11.2.6.1. The second layer from the outside shall have not less than 14 nor more than 18 wires. The outer layer shall have not less than 20 nor more than 24 wires. Wires in the second layer from the outside shall be of one diameter. Wires in the outer layer shall be of one diameter. Each strand shall be fabricated in three operations.

3.11.5.3 Type I, general purpose, class 5, construction 2, 6 by 61 (2 operations). Wire ropes shall have 1 core and 6 strands of not less than 51 nor more than 74 wires each, totaling not less than 306 nor more than 444 wires in the strands. This construction is not furnished in lang lay and it is not furnished preformed. This construction shall not be required in sizes smaller than 2 inches.

3.11.5.3.1 Each strand shall have 1 center strand of 19 to 26 wires constructed in accordance with 3.11.2.3.1, 3.11.2.4.1, 3.11.2.5.1, or 3.11.2.6.1. The second layer from the outside shall have not less than 16 nor more than 24 wires. The outer layer shall have not less than 16 nor more than 24 wires. Wires in the second layer from the outside shall be of one diameter. Wires in the outer layer shall be of one diameter. Each strand shall be fabricated in two operations.

3.11.5.4 Type I, general purpose, class 5, construction 3, 6 by 61 (2 operations). Wire ropes shall have 1 core and 6 strands of not less than 51 nor more than 73 wires each, totaling not less than 306 nor more than 438 wires in the strands. This construction is not furnished in lang lay and it is not furnished preformed. This construction shall not be required in sizes smaller than 2 inches.

3.11.5.4.1 Each strand shall have 1 center strand of 31 to 49 wires constructed in accordance with 3.11.3.5.1, 3.11.3.6.1, 3.11.3.7.1, 3.11.3.8.1 or 3.11.3.9.1. The outside layer shall have not less than 16 nor more than 24 wires. Wires in the outside layer shall be of one diameter. Each strand shall be fabricated in two operations.

3.11.5.5 Type I, general purpose, class 5, construction 4, 6 by 61 (Filler wire-Seale). Wire ropes shall have 1 core and 6 strands of not less than 55 nor more than 61 wires each, totaling not less than 330 nor more than 366 wires in the strand. This construction shall not be required in sizes smaller than 2 inches.

3.11.5.5.1 Each strand shall have one wire center, either 8 or 9 inner wires, either 16 or 18 intermediate wires, and either 16 or 18 outer wires. There shall be a layer of either 8 or 9 filler wires between the inner and intermediate layers. Wires in the inner layer shall be of one diameter. Wires in the intermediate layer shall be of one diameter. Wires in the outside layer shall be of one diameter. Filler wires shall be of one diameter.

3.11.5.6 Type I, general purpose, class 5, construction 5, 6 by 61 (Seale-Warrington-Seale). Wire ropes shall have 1 core and 6 strands of 55 wires each, totaling 330 wires in the strands. This construction shall not be required in sizes smaller than 2 inches.

3.11.5.6.1 Each strand shall have 1 center wire, 9 inner wires, 9 inside intermediate wires, 18 outside intermediate wires, and 18 outer wires. Wires in the inner layer shall be of one diameter. Wires in the inside intermediate layer shall be of one diameter. Wires in the outside intermediate layer shall be of two diameters laid alternately. Wires in the outer layer shall be of one diameter. Each strand shall be fabricated in one operation.

3.11.5.7 Type I, general purpose, class 5, construction 6, 6 by 61 (Seale-Filler wire-Seale). Wire ropes shall have 1 core and 6 strands of 57 or 64 wires each, totaling 342 or 384 wires in the strands. This construction shall not be required in sizes smaller than 2 inches.

3.11.5.7.1 Each strand shall have 1 center wire, 8 or 9 inner wires, 8 or 9 inside intermediate wires, 16 or 18 outside intermediate wires, and 16 or 18 outer wires. There shall be either 8 or 9 filler wires between the inside and outside intermediate layers. Wires in the inner layer shall be of one diameter. Wires in the inside intermediate layer shall be of one diameter. Wires in the outside intermediate layer shall be of one diameter. Wires in the outer layer shall be of one diameter. Filler wires shall be of one diameter. Each strand shall be fabricated in one operation.

3.11.6 Type I, general purpose, class 6, 6 by 91 (see figure 26).

3.11.6.1 Material. Material shall be of improved plow or extra improved plow steel as specified (see 3.1 and 6.2(s-1)).

3.11.6.1.1 Finish. Wire rope of improved plow steel or extra improved plow steel shall be of uncoated (bright) or zinc coated (drawn galvanized) wire as specified (see 3.3.5 and 6.2(s-2)).

3.11.6.1.2 Cores. Wire ropes of improved plow steel shall have either fiber core, wire strand core, or IWRC as specified (see 3.2 and 6.2(s-3)). Wire ropes of extra improved plow steel shall be IWRC in accordance with 3.2.3.

3.11.6.1.3 Fabrication. Wire ropes shall be fabricated as specified (see 3.4 and 6.2(s-4)).

3.11.6.1.4 Lay. Unless otherwise specified (see 6.2(s-5)), the lay shall be right regular lay in accordance with 3.4.4.1.

3.11.6.1.5 Dimensions, weight, and strength. Dimensions, weight, and strength requirements shall be as specified in tables XXIII, XXIV, and XXV.

3.11.6.2 Type I, general purpose, class 6, construction 1, 6 by 91 (4 operations). Wire ropes shall have 1 core and 6 strands of not less than 79 nor more than 98 wires each, totaling not less than 474 nor more than 588 wires in the strands. This construction is not furnished in lang lay and it is not furnished preformed. This construction shall not be required in sizes smaller than 2-1/2 inches.

3.11.6.2.1 Each strand shall have 1 center strand of 19 to 26 wires constructed in accordance with 3.11.2.3.1, 3.11.2.4.1, 3.11.2.5.1, or 3.11.2.6.1. The third layer from the outside shall have not less than 14 nor more than 18 wires. The second layer from the outside shall have not less than 20 nor more than 24 wires. The outer layer shall have not less than 26 nor more than 30 wires. Wires in the third layer from the outside shall be of one diameter. Wires in the second layer from the outside shall be of one diameter. Wires in the outer layer shall be of one diameter. Each strand shall be fabricated in four operations.

3.11.6.3 Type I, general purpose, class 6, construction 2, 6 by 91 (3 operations). Wire ropes shall have 1 core and 6 strands of not less than 79 nor more than 110 wires each, totaling not less than 474 nor more than 660 wires in the strands. This construction is not furnished in lang lay and it is not furnished preformed. This construction shall not be required in sizes smaller than 2-1/2 inches.

3.11.6.3.1 Each strand shall have 1 center strand of 19 to 26 wires constructed in accordance with 3.11.2.3.1, 3.11.2.4.1, 3.11.2.5.1, or 3.11.2.6.1. The third layer from the outside shall have not less than 16 nor more than 24 wires. The second layer from the outside shall have not less than 22 nor more than 30 wires. The outer layer shall have not less than 22 nor more than 30 wires. Wires in the third layer from the outside shall be of one diameter. Wires in the second layer from the outside shall be of one diameter. Wires in the outer layer shall be of one diameter. Each strand shall be fabricated in three operations.

3.11.6.4 Type I, general purpose, class 6, construction 3, 6 by 91 (3 operations). Wire ropes shall have 1 core and 6 strands of not less than 75 nor more than 103 wires each, totaling not less than 450 nor more than 618 wires in the strands. This construction is not furnished in lang lay and it is not furnished preformed. This construction shall not be required in sizes smaller than 2-1/2 inches.

3.11.6.4.1 Each strand shall have 1 center strand of 29 to 49 wires constructed in accordance with 3.11.3.5.1, 3.11.3.6.1, 3.11.3.7.1, 3.11.3.8.1, or 3.11.3.9.1. The second layer from the outside shall have not less than 20 nor more than 24 wires. The outer layer shall have not less than 26 nor more than 30 wires. Wires in the second layer from the outside shall be of one diameter. Wires in the outer layer shall be of one diameter. Each strand shall be fabricated in three operations.

3.11.6.5 Type I, general purpose, class 6, construction 4, 6 by 91 (2 operations). Wire ropes shall have 1 core and 6 strands of not less than 75 nor more than 109 wires each, totaling not less than 450 nor more than 654 wires in the strands. This construction is not furnished in lang lay and it is not furnished preformed. This construction shall not be required in sizes smaller than 2-1/2 inches.

3.11.6.5.1 Each strand shall have 1 center strand of 31 to 49 wires constructed in accordance with 3.11.3.5.1, 3.11.3.6.1, 3.11.3.7.1, 3.11.3.8.1, or 3.11.3.9.1. The second layer from the outside shall have not less than 22 nor more than 30 wires. The outer layer shall have not less than 22 nor more than 30 wires. Wires in the second layer from the outside shall be of one diameter. Wires in the outer layer shall be of one diameter. Each strand shall be fabricated in two operations.

3.12 Type II, elevator.

3.12.1 Material. Material shall be of iron or traction steel as specified (see 3.1 and 6.2(t-1)). When specified (see 6.2(t-1)), elevator wire ropes of 11/16, 13/16, and 15/16-inch diameters may be of high-rise special steel of greater strengths.

3.12.1.1 Finish. Elevator wire ropes shall be of uncoated (bright) wires in accordance with 3.3.5.1.

3.12.1.2 Cores. Cores shall be fiber cores in accordance with 3.2.1 or 3.2.5.

3.12.1.3 Fabrication. Steel wire ropes shall be fabricated as specified (see 3.4 and 6.2(t-2)). Iron wire ropes shall be non-preformed in accordance with 3.4.

3.12.1.4 Lay. Lay shall be right regular lay in accordance with 3.4.4.1.

3.12.1.5 Dimensions, weight, and strength. Dimensions, weight, and strength requirements shall be as specified in tables XXVI, XXVII, and XXVIII.

3.12.2 Type II, elevator, class 1, 6 by 19.

3.12.2.1 Type II, elevator, class 1, construction 1, 6 by 19 (Warrington) (see figure 7). Wire ropes shall have 1 core and 6 strands of 19 wires each, totaling 114 wires in the strands. This construction shall not be required in sizes larger than 5/16 inch.

3.12.2.1.1 Strands shall be in accordance with 3.11.2.3.1.

3.12.2.2 Type II, elevator, class 1, construction 2, 6 by 19 (Filler wire) (see figure 9). Wire ropes shall have 1 core and 6 strands of not less than 21 and not more than 25 wires each, totaling not less than 126 nor more than 150 wires in the strands. This construction shall not be required in sizes smaller than 3/8 inch.

3.12.2.2.1 Strands shall be in accordance with 3.11.2.5.1.

3.12.2.3 Type II, elevator, class 1, construction 3, 6 by 19 (Warrington-Seale) (see figure 10). Wire ropes shall have 1 core and 6 strands of 26 wires each, totaling 156 wires in the strands. This construction shall not be required in sizes smaller than 3/8 inch.

3.12.2.3.1 Each strand shall be in accordance with 3.11.2.6.1.

3.12.3 Type II, elevator, class 2, 8 by 19.

3.12.3.1 Type II, elevator, class 2, construction 1, 8 by 19 (2 operations) (see figure 20). Wire ropes shall have 1 core and 8 strands of 19 wires each, totaling 152 wires in the strands. This construction shall not be required in sizes smaller than 1/4 inch.

3.12.3.1.1 Each strand shall be in accordance with 3.11.2.2.1.

3.12.3.2 Type II, elevator, class 2, construction 2, 8 by 19 (Warrington) (see figure 21). Wire ropes shall have 1 core and 8 strands of 19 wires each, totaling 152 wires in the strands. This construction shall be required only in 1/4-inch through 7/16-inch sizes.

3.12.3.2.1 Each strand shall be in accordance with 3.11.2.3.1.

3.12.3.3 Type II, elevator, class 2, construction 3, 8 by 19 (Seale) (see figure 22). Wire ropes shall have 1 core and 8 strands of 19 wires each, totaling 152 wires in the strands.

3.12.3.3.1 Each strand shall be in accordance with 3.11.2.4.1.

3.12.3.4 Type II, elevator, class 2, construction 4, 8 by 19 (Filler wire) (see figure 23). Wire ropes shall have 1 core and 8 strands of not less than 21 nor more than 25 wires each, totaling not less than 168 nor more than 200 wires in the strands. This construction shall not be required in sizes smaller than 7/16 inch.

3.12.3.4.1 Strands shall be in accordance with 3.11.2.5.1.

3.12.3.5 Type II, elevator, class 2, construction 5, 8 by 19 (Warrington-Seale) (see figure 24). Wire ropes shall have 1 core and 8 strands of 26 wires each totaling 208 wires in the strands. This construction shall not be required in sizes smaller than 3/8 inch.

3.12.3.5.1 Each strand shall be in accordance with 3.11.2.6.1.

3.13 Type III, marine (cables).

3.13.1 Type III, marine (cables), class 1, 6 by 6, (deck lashing ropes) (see figure 27). Deck lashing ropes shall have 1 core and 6 strands of 1 fiber center and 6 wires each, totaling 36 wires in the strands.

3.13.1.1 Each strand shall have 1 fiber center and 6 outer wires. Wires in the outer layer shall be of one diameter. Each strand shall be fabricated in one operation.

3.13.1.2 Material. Material shall be of improved plow steel as specified in 3.1.

3.13.1.3 Finish. Wire ropes shall be of uncoated or coated (galvanized) wires as specified (see 3.3.5 and 6.2(u-1)).

3.13.1.4 Centers and cores. Strand centers and wire rope cores shall be of fiber in accordance with 3.2.1 or 3.2.5.

3.13.1.5 Fabrication. Wire ropes shall be preformed in accordance with 3.4.

3.13.1.6 Lay. Lay shall be of right regular lay in accordance with 3.4.4.1.

3.13.1.7 Dimensions, weight, and strength. Dimensions, weight, and strength requirements shall be as specified in table XXIX.

3.13.2 Type III, marine (cables), class 2, 6 by 12 (running ropes) (see figure 28). Running rope shall have 1 core and 6 strands of 1 fiber center and 12 wires each, totaling 72 wires in the strands.

3.13.2.1 Each strand shall have 1 fiber center and 12 outer wires. Wires in the outer layer shall be of one diameter. Each strand shall be fabricated in one operation.

3.13.2.2 Material. Material shall be improved plow steel or phosphor bronze as specified (see 3.1 and 6.2(v-1)).

3.13.2.3 Finish. Wire ropes of steel shall be of zinc coated (galvanized) wires in accordance with 3.3.5.2.

3.13.2.4 Centers and cores. Wire ropes shall have strand centers and rope cores of fiber in accordance with 3.2.1 or 3.2.5.

3.13.2.5 Fabrication. Wire ropes shall be fabricated as specified (see 3.4 and 6.2(v-2)).

3.13.2.6 Lay. Lay shall be of right regular lay in accordance with 3.4.4.1.

3.13.2.7 Dimensions, weight, and strength. Dimensions, weight, and strength requirements shall be as specified in tables XXX and XXXI.

3.13.3 Type III, marine (cables), class 3, 6 by 24 mooring lines.

3.13.3.1 Material. Material shall be improved plow steel as specified in 3.1.

3.13.3.1.1 Finish. Wire ropes shall be of zinc coated (galvanized) wires in accordance with 3.3.5.2.

3.13.3.1.2 Centers and cores. Wire ropes shall have strand centers and rope cores of fiber as specified in 3.2.1 or 3.2.5.

3.13.3.1.3 Fabrication. Wire ropes shall be fabricated as specified (see 3.4 and 6.2(w-1)).

3.13.3.1.4 Lay. Lay shall be of right regular lay in accordance with 3.4.4.1.

3.13.3.1.5 Dimensions, weight, and strength. Dimensions, weight, and strength requirements shall be as specified in table XXXII.

3.13.3.2 Type III, marine (cables), class 3, 6 by 24 (mooring lines), construction 1, (2 operations) (see figure 29). Wire rope shall have 1 core and 6 strands of 1 fiber center and 24 wires each, totaling 144 wires in the strands.

3.13.3.2.1 Each strand shall have 1 fiber center, 9 wires in the inner layer and 15 wires in the outer layer. Wires in the inner layer shall be of one diameter. Wires in the outer layer shall be of one diameter. Each strand shall be fabricated in 2 operations.

3.13.3.3 Type III, marine (cables), class 3, 6 by 24 (mooring lines), construction 2, (Warrington) (see figure 30). Wire rope shall have 1 core and 6 strands of 1 fiber center and 24 wires each, totaling 144 wires in the strands.

3.13.3.3.1 Each strand shall have 1 fiber center, 8 wires in the inner layer and 16 wires in the outer layer. Wires in the inner layer shall be of one diameter. Wires in the outer layer shall be of two diameters laid alternately. Each strand shall be fabricated in one operation.

3.13.3.4 Type III, marine (cables), class 3, 6 by 24 (mooring lines), construction 3, (Seale) (see figure 31). Wire rope shall have 1 core and 6 strands of 1 fiber center and 24 wires each, totaling 144 wires in the strands.

3.13.3.4.1 Each strand shall have 1 fiber center, 12 wires in the inner layer and 12 wires in the outer layer. Wires in the inner layer shall be of one diameter. Wires in the outer layer shall be of one diameter. Each strand shall be fabricated in one operation.

3.13.4 Type III, marine (cables), class 4, 6 by 3 by 7 spring lay (see figure 32). Wire rope shall have 1 core and 6 strands of 1 fiber center and 6 substrands (3 fiber and 3 steel) each, totaling 126 wires in the steel strands.

3.13.4.1 Each steel substrand shall be in accordance with 3.11.1. Each strand shall have 1 fiber center, 3 fiber substrands, and 3 steel substrands of 7 wires each, totaling 21 wires laid alternately.

3.13.4.2 Material. Material shall be of improved plow steel as specified in 3.1.

3.13.4.2.1 Finish. Wire ropes shall be of zinc coated (galvanized) wire in accordance with 3.3.5.2.

3.13.4.2.2 Centers and cores. Centers and cores shall be fiber in accordance with 3.2.1. The alternate (main) fiber strands showing on the surface of the finished spring lay rope shall be made of either polypropylene fiber or a good quality hard fiber. A mixture of two or more kinds of hard fiber may be used.

3.13.4.2.2.1 Preservation and lubrication. Fiber parts shall be treated with a lubricating compound blended to give proper lubricity and water repellency. The materials used shall not accelerate deterioration of the fiber parts during storage or weathering of the spring lay rope, nor adversely affect its handling qualities or durability. This requirement is not applicable to polypropylene parts (see MIL-P-24216).

3.13.4.2.3 Fabrication. Wire rope shall be preformed in accordance with 3.4. This rope shall not be required to meet the requirement of 4.4.5.2.

3.13.4.2.4 Lay. Lay shall be of right regular lay in accordance with 3.4.4.1.

3.13.4.2.5 Dimensions, weight, and strength. Dimensions, weight, and strength requirements shall be as specified in table XXXIII.

3.13.5 Type III, marine (cables), class 5, 6 by 3 by 19 spring lay.

3.13.5.1 Material. Material shall be improved plow steel as specified in 3.1.

3.13.5.1.1 Finish. Wire rope shall be coated as specified (see 3.3.5 and 6.2(x-1)).

3.13.5.1.2 Centers and cores. Centers and cores shall be as specified in 3.13.4.2.2.

3.13.5.1.3 Fabrication. Wire rope shall be preformed in accordance with 3.4. This rope shall not be required to meet the requirement of 4.4.5.2.

3.13.5.1.4 Lay. Lay shall be of right regular lay in accordance with 3.4.4.1.

3.13.5.1.5 Dimensions, weight, and strength. Dimensions, weight, and strength requirements shall be as specified in table XXXIII.

3.13.5.2 Type III, marine (cables), class 5, 6 by 3 by 19 spring lay, construction 1, (2 operations) (see figure 33). Wire rope shall have 1 core and 6 strands of 1 fiber center and 6 substrands (3 fiber and 3 steel) each, totaling 342 wires in the steel strands.

3.13.5.2.1 Each steel substrand shall be in accordance with 3.13.4.2. Each strand shall have 1 fiber center, 3 fiber substrands, and 3 steel substrands of 19 wires each, totaling 57 wires laid alternately.

3.13.5.3 Type III, marine (cables), class 5, 6 by 3 by 19 spring lay, construction 2, (Warrington) (see figure 34). Wire rope shall have 1 core and 6 strands of 1 fiber center and 6 substrands (3 fiber and 3 steel) each, totaling 342 wires in the steel strands.

3.13.5.3.1 Each steel substrand shall be in accordance with 3.11.2.3.1. Each strand shall have 1 fiber center, 3 fiber substrands, and 3 steel substrands of 19 wires each, totaling 57 wires laid alternately.

3.13.5.4 Type III, marine (cables), class 5, 6 by 3 by 19 spring lay, construction 3, (Seale) (see figure 35). Wire rope shall have 1 core and 6 strands of 1 fiber center and 6 substrands (3 fiber and 3 steel) each, totaling 342 wires in the steel strands.

3.13.5.4.1 Each steel substrand shall be in accordance with 3.11.2.4.1. Each strand shall have 1 fiber center, 3 fiber substrands and 3 steel substrands of 19 wires each, totaling 57 wires laid alternately.

3.13.5.5 Type III, marine (cables), class 6, 6 by 42 tiller or hand control ropes (see figure 36). Wire rope shall have 1 core and 6 strands of 1 fiber center and 6 substrands each, totaling 252 wires in the strands.

3.13.5.5.1 Each steel substrand shall be in accordance with 3.11.1. Each strand shall have 1 fiber center and 6 substrands of 7 wires each, totaling 42 wires.

3.13.5.5.2 Material. Material shall be improved plow steel or phosphor bronze as specified (see 3.1 and 6.2(y-1)).

3.13.5.5.2.1 Finish. Wire ropes of improved plow steel shall be either zinc coated or uncoated (bright) wires, as specified (see 6.2(y-2)), in accordance with 3.3.5.

3.13.5.5.2.2 Centers and cores. Centers and cores shall be fiber in accordance with 3.2.1 or 3.2.5.

3.13.5.5.2.3 Fabrication. Wire ropes shall be non-preformed in accordance with 3.4.3.2.

3.13.5.5.2.4 Lay. Lay shall be right regular lay in accordance with 3.4.4.1.

3.13.5.5.2.5 Dimensions, weight, and strength. Dimensions, weight, and strength requirements shall be in accordance with tables XXXIV and XXXV.

3.14 Type IV, miscellaneous.

3.14.1 Type IV, miscellaneous, class 1, 5 by 19 marline-clad.

3.14.1.1 Material. Wire ropes shall be of improved plow steel as specified in 3.1.

3.14.1.2 Finish. Wire ropes shall be of uncoated (bright) wires in accordance with 3.3.5.1.

3.14.1.3 Cores. Wire ropes shall have fiber cores in accordance with 3.2.1 or 3.2.5.

3.14.1.4 Fabrication. Wire ropes shall be preformed in accordance with 3.4.3.1.

3.14.1.5 Lay. Lay shall be of right regular lay in accordance with 3.4.4.1.

3.14.1.6 Dimensions, weight, and strength. Dimensions, weight, and strength requirements shall be in accordance with table XXXVI.

3.14.2 Type IV, miscellaneous, class 1, 5 by 19 marline-clad, construction 1, (2 operations) (see figure 37). Wire rope shall have 1 core and 5 strands of 19 wires each, totaling 95 wires in the strands.

3.14.2.1 Each strand shall be in accordance with 3.11.2.2.1. Each strand shall be served with marline wound tightly on the strand so that it is firm, durable, uniformly smooth, and free from imperfections.

3.14.2.2 Type IV, miscellaneous, class 1, 5 by 19 marline-clad, construction 2, (Warrington) (see figure 38). Wire rope shall have 1 core and 5 strands of 19 wires each, totaling 95 wires in the strands.

3.14.2.2.1 Each strand shall be in accordance with 3.11.2.3.1. Each strand shall be served with marline wound tightly on the strand so that it is firm, durable, uniformly smooth, and free from imperfections.

3.14.2.3 Type IV, miscellaneous, class 1, 5 by 19 marline-clad, construction 3, (Filler wire) (see figure 39). Wire rope shall have 1 core and 5 strands of not less than 21 nor more than 25 wires each, totaling not less than 105 nor more than 125 wires in the strands.

3.14.2.3.1 Each strand shall be in accordance with 3.11.2.5.1. Each strand shall be served with marline wound tightly on the strand so that it is firm, durable, uniformly smooth, and free from imperfections.

3.14.3 Type IV, miscellaneous, class 2, 18 by 7 rotation resistant (see figure 40). Wire rope shall have 1 core, 6 strands of 7 wires each, totaling 42 wires in the inner layer and 12 strands of 7 wires each totaling 84 wires in the outer layer. The inner rope layer shall be lang lay, left lay, whereas the outer rope layer shall be regular lay, right lay. The wire rope shall be closed in 2 operations. Total number of wires in the rope shall be 126.

3.14.3.1 Each strand shall be in accordance with 3.11.1, except for material and lay.

3.14.3.1.1 Material. Wire ropes shall be of improved plow steel or extra improved plow steel as specified in 3.1.

3.14.3.1.2 Finish. Wire ropes shall be uncoated (bright) or zinc coated (drawn galvanized) as specified (see 3.3.5 and 6.2(z-1)).

3.14.3.1.3 Cores. Unless otherwise specified (see 6.2(z-2)), cores shall be either fiber or wire strand at option of the contractor (see 3.2.1, 3.2.2 and 6.2(z-2)).

3.14.3.1.4 Fabrication. Wire rope shall be preformed in accordance with 3.4.3.1.

3.14.3.1.5 Lay.

3.14.3.1.5.1 Inner layer. The 6 inner strands in the ropes shall be of a left lang lay in accordance with 3.4.4.4 laid around a fiber core or a wire strand core.

3.14.3.1.5.2 Outer layer. The 12 strands in the outer layer shall be laid around the first layer in a right regular lay in accordance with 3.4.4.1.

3.14.3.1.6 Dimensions, weight, and strength. Dimensions, weight, and strength requirements shall be in accordance with tables XXXVII and XXXVIII.

3.14.4 Type IV, miscellaneous, class 3, flattened strand.

3.14.4.1 Material. Material shall be of improved plow steel or extra improved plow steel as specified in 3.1.

3.14.4.1.1 Finish. Wire ropes shall be of uncoated (bright) wires in accordance with 3.3.5.1.

3.14.4.1.2 Cores. Wire ropes of improved plow steel shall have fiber, wire strand, or independent wire rope cores as specified (see 3.2 and 6.2(aa-1)). Wire ropes of extra improved plow steel shall have a wire strand or IWRC as specified (see 3.2.2, 3.2.3, and 6.2(aa-1)).

3.14.4.1.3 Fabrication. Wire ropes shall be fabricated as specified (see 3.4 and 6.2(aa-2)).

3.14.4.1.4 Lay. Lay shall be right lang lay in accordance with 3.4.4.3.

3.14.4.1.5 Dimensions, weight, and strength. Dimensions, weight, and strength requirements shall be in accordance with tables XXXIX, XL, and XLI.

3.14.4.2 Type IV, miscellaneous, class 3, flattened strand, construction 1, 6 by 25, style B (see figure 41). Wire rope shall have 1 core and 6 strands of 1 triangular wire center and 24 wires each, totaling 144 wires and 6 triangular wire centers in the strands.

3.14.4.2.1 Each strand shall have 1 triangular-wire center, 12 round wires in the inner layer, and 12 round wires in the outer layer. Wires in the inner layer shall be of one diameter. Wires in the outer layer shall be of one diameter. Each strand shall be fabricated in two operations.

3.14.4.3 Type IV, miscellaneous, class 3, flattened strand, construction 2, 6 by 30, style G (see figure 42). Wire rope shall have 1 core and 6 strands of 1 triangular shaped center of 6 wires and 24 wires each, totaling 180 wires in the strands.

3.14.4.3.1 Each strand shall have 1 triangular-shaped center, 12 wires in the inner layer, and 12 wires in the outer layer. Each triangular-shaped center shall have 6 round wires. Each pair of the wires shall be twisted together, then the 3 pairs twisted together so that the cross-section of the center is triangular. There may be filler wires in the center. Wires in the inner layer shall be of one diameter. Wires in the center layer shall be of one diameter. Wires in the outer layer shall be of one diameter. Each strand shall be fabricated in either two or three operations.

3.14.4.4 Type IV, miscellaneous, class 3, flattened strand, construction 3, 6 by 27, style H (see figure 43). Wire rope shall have 1 core and 6 strands of 27 wires each, totaling 162 wires in the strands.

3.14.4.4.1 Each strand shall have 1 triangular-shaped center consisting of 3 round wires, 12 round wires in the inner layer, and 12 round wires in the outer layer. Wires in the inner layer shall be of one diameter. Wires in the center layer shall be of one diameter. Wires in the outer layer shall be of one diameter. Each strand shall be fabricated in either two or three operations.

3.14.4.5 Type IV, miscellaneous, class 3, flattened strand, construction 4, 6 by 31, style V (see figure 44). Wire rope shall have 1 core and 6 strands of triangular-shaped brangled center strand of 6 or 7 wires and 24 wires each, totaling either 180 or 186 wires in the strands.

3.14.4.5.1 Each strand shall have 1 triangular-shaped brangled center strand, 12 wires in the inner layer, and 12 wired in the outer layer. Each triangular-shaped brangled strand shall have either a fiber center or a round wire center with 6 round wires laid around it and brangled so that the cross-section of the center strand is triangular. Wires in the center layer shall be of one diameter. Wires in the inner layer shall be of one diameter. Wires in the outer layer shall be of one diameter. Each strand shall be fabricated in either 2 or 3 operations.

3.14.5 Type IV, miscellaneous, class 4, 8 by 19 rotation resistant.

3.14.5.1 Material. Wire rope shall be of improved plow steel or extra improved plow steel as specified in 3.1.

3.14.5.2 Finish. Wire ropes shall be of uncoated (bright) wires or zinc coated (galvanized) wires in accordance with 3.3.5.

3.14.5.3 Core. Wire rope shall have an independent wire rope core in accordance with 3.2.3 and it shall be left lang lay in accordance with 3.4.4.4.

3.14.5.4 Fabrication. Wire rope shall be preformed in accordance with 3.4.3.1.

3.14.5.5 Lay. Wire rope lay shall be right regular lay in accordance with 3.4.4.1.

3.14.5.6 Dimensions, weight, and strength. Dimensions, weight, and strength requirements shall be in accordance with tables XLII and XLIII.

3.14.5.7 Type IV, miscellaneous, class 4, construction 1, 8 by 19 rotation resistant (Seale) (see figure 45). Wire ropes shall have 1 core and 8 strands of 19 wires each, totaling 152 wires in the strands.

3.14.5.7.1 Each strand shall be in accordance with 3.11.2.4.1.

3.14.5.8 Type IV, miscellaneous, class 4, construction 2, 8 by 19 rotation resistant (Filler wire) (see figure 46). Wire ropes shall have 1 core and 8 strands of not less than 21 wires and not more than 25 wires each, totaling not less than 168 nor more than 200 wires in the strands.

3.14.5.8.1 Each strand shall be in accordance with 3.11.2.5.1.

3.14.5.9 Type IV, miscellaneous, class 4, construction 3, 8 by 19 rotation resistant (Warrington-Seale) (see figure 47). Wire ropes shall have 1 core and 8 strands of 26 wires each, totaling 208 wires in the strands.

3.14.5.9.1 Each strand shall be in accordance with 3.11.2.6.1.

3.15 Type V, auxiliary wire strands.

3.15.1 Type V, auxiliary wire strands, class 1, 1 by 7 seizing strand (see figure 48). The strand shall have 1 wire center and 6 outer wires. Wires in the outer layer shall be of one diameter. The strand shall be fabricated in 1 operation and shall have 7 wires.

3.15.1.1 Material. Material shall be of iron, annealed steel, or corrosion-resistant steel as specified (see 3.1 and 6.2(bb-1)).

3.15.1.2 Finish. Wires shall be zinc coated in accordance with 3.3.5.2 except corrosion-resistant steel which shall be uncoated.

3.15.1.3 Fabrication. Wire strand shall be fabricated as specified (see 3.4 and 6.2(bb-2)).

3.15.1.4 Lay. Strands shall be left regular lay in accordance with 3.4.4.2.

3.15.1.5 Dimensions, weight, and strength. Dimensions, weight, and strength requirements shall be in accordance with table XLIV.

3.15.2 Type V, auxiliary wire strands, class 2, 1 by 19 seizing strand (2 operations) (see figure 49). The strand shall have 1 wire center, 6 wires in the inner layer, and 12 wires in the outer layer. Wires in the inner layer shall be of one diameter. Wires in the outer layer shall be of one diameter. The strand shall be fabricated in 2 operations and shall have 19 wires.

3.15.2.1 Material. Material shall be of iron or annealed steel as specified (see 3.1 and 6.2(cc-1)).

3.15.2.2 Finish. Wires shall be zinc coated in accordance with 3.3.5.

3.15.2.3 Fabrication. Wire strand shall be fabricated as specified (see 3.4 and 6.2(cc-2)).

3.15.2.4 Lay. Strands shall be left regular lay in accordance with 3.4.4.2.

3.15.2.5 Dimensions, weight, and strength. Dimensions, weight, and strength requirements shall be in accordance with table XLV.

3.16 Type VI, small cords.

3.16.1 Material. Material shall be of high quality carbon steel or corrosion-resistant steel suitable for the purpose and as specified (see 3.1 and 6.2(dd-1)).

3.16.2 Finish. Wire rope of corrosion-resistant steel shall be of uncoated (bright) wire. Wire rope of carbon steel shall be of zinc coated (drawn galvanized) wires (see 3.3.5).

3.16.3 Cores. Cores for class 2 and class 3 shall be wire strand (see 3.2.2). Class 1 shall have no core.

3.16.4 Fabrication. Wire rope shall be preformed and fabricated in accordance with 3.4. The diameter at the cut end shall not increase more than shown in table XLVI.

3.16.5 Lay. The lay shall be right regular lay in accordance with 3.4.4.1.

3.16.6 Dimensions, weight, and strength. Dimensions, weight, and strength requirements shall be in accordance with table XLVI.

3.16.7 Type VI, small cords, class 1, 3 by 7 (see figure 50). Wire rope shall have 3 strands of 7 wires each, totaling 21 wires laid together without a core. This class shall be required only in sizes 1/32 and 3/64.

3.16.7.1 Each strand shall be in accordance with 3.11.1.1.

3.16.8 Type VI, small cords, class 2, 7 by 7 (see figure 51). Wire rope shall have 6 strands of 7 wires each, totaling 42 wires laid around a wire strand core also of 7 wires. This class shall be required only in sizes 3/64, 1/16, and 3/32.

3.16.8.1 Each strand, including the wire strand core, shall be in accordance with 3.11.1.1.

3.16.9 Type VI, small cord, class 3, 7 by 19 (2 operations) (see figure 52). Wire rope shall have 6 strands of 19 wires each, totaling 114 wires laid around a wire strand core also of 19 wires. This class shall be required only in sizes 1/16 through 3/8.

3.16.9.1 Each strand, including the wire strand core, shall be in accordance with 3.11.2.2.1.

3.17 Commercially available and special application constructions.

3.17.1 Table L is a summary of the wire rope and strand constructions that are commercially available.

3.17.2 Table LI is a summary of wire rope and strand construction used for special applications.

4. QUALITY ASSURANCE PROVISIONS

4.1 Responsibility for inspection. Unless otherwise specified in the contract, the contractor is responsible for the performance of all inspection requirements as specified herein. Except as otherwise specified in the contract, the contractor may use his own or any other facilities suitable for the performance of the inspection requirements specified herein, unless disapproved by the government. The government reserves the right to perform any of the inspections set forth in the specification where such inspections are deemed necessary to assure that supplies and services conform to prescribed requirements.

4.2 Sampling.

4.2.1 Lot. A lot shall consist of all the wire rope or strand of one type, class, construction, size, and material presented for delivery at one time on the same contract or order.

4.2.1.1 When wire rope or strand can be identified by its manufacturing reel, one sample 12 feet long shall be taken from one shipping reel in the lot cut from the same manufacturing reel.

4.2.1.2 When wire rope or strand cannot be identified by its manufacturing reel, one sample 12 feet long shall be cut from each reel or coil submitted for inspection.

4.2.1.3 The 12-foot samples shall be seized and cut into two pieces: a 3-foot length and a 9-foot length. Hereinafter, the 3-foot length shall be identified as the short sample and the 9-foot length as the long sample.

4.2.2 Sampling for zinc coating. A minimum of four specimens of a convenient length but not less than 12 inches each, cut from each size wire used in the rope, shall be randomly selected from the short samples.

4.3 Visual and dimensional examination. Each reel (or coil) in the lot shall be visually examined for workmanship and lubrication, measured for dimensional requirements, and weighed.

4.3.1 Examination of diameter. The examination of the wire rope or strand diameter shall be made at the free end of the rope or strand in the shipping reel. Beginning not less than 5 feet from the end of the rope or strand, the diameter shall be measured at three places not less than 5 feet apart with a slide caliper as shown on figure 53. The average of the measured diameters shall be the diameter of the rope or strand inspection.

4.3.2 Examination of pitch. The examination of the pitch, or of the lay length, shall be made at the free end of the wire rope or strand on the shipping reel. Beginning not less than 10 feet from the end of the rope, the length of 5 or more pitches shall be measured. The distance measured on a straight length of rope shall be divided by the number of pitches, in order to arrive at the pitch size of the length of a single lay.

4.3.3 Examination for lubricant. The examination of wire strands and cores for lubrication shall be made during the closing of the wire rope. The lubricant shall be sufficient to coat the wire strands, wire cores, independent wire rope cores, and to impregnate fiber cores as specified in 3.6.

4.4 Test methods.

4.4.1 Tensile strength.

4.4.1.1 Tensile strength test of finished wire ropes and strands. The strength of wire ropes or strands shall be determined from the long samples. The acceptance breaking strength shall be as shown in the applicable tables herein. The free length of wire rope or strand shall be as shown in table XLVII. The rope ends shall be terminated in zinc poured sockets or other approved attachments. The loading conditions shall conform to the requirements of ASTM E 8 or ASTM E 8M. A failure less than the acceptance breaking strength that occurs within three times the rope or strand diameter of the end attachment shall be considered "no test" and further testing shall proceed as though the test never occurred.

4.4.1.2 Tensile test of main wires. Unless otherwise specified (see 6.2(ee)), the test specified in 4.4.1.2.1 is not required.

4.4.1.2.1 From each short sample, not less than one specimen of each diameter of wire from each wire strand and not less than 6 specimens from each sample shall be selected and the tensile strength determined in accordance with ASTM E 8 or ASTM E 8M. The free length of wires shall be not less than 10 inches. The speed of the movable head of the testing machine under no load shall be not more than 1 inch per minute. The tensile strength of the main wires shall conform to the tensile strength requirements shown in table I.

4.4.2 Torsion test. When specified (see 6.2(ff)), the tests specified in 4.4.2.1 and 4.4.2.2 shall be required.

4.4.2.1 From each short sample (see 4.4.1.2.1), not less than one specimen of each size of main wires from each strand shall be taken. The total number of specimens shall be not more than 25 percent of the total number of main wires. The distance between the jaws of the testing machine shall be $8 \pm 1/16$ inches. One clamp in the testing machine shall be movable parallel to the axis of the tested wire and an axial tensile force in accordance with table XLVIII shall be applied to keep the tested wire straight during the test. The tested wire shall be twisted by rotating one or both of the clamps at a uniform rate of not more than 60 revolutions per minute. The wires shall not break when one end is held and the other rotated the number of revolutions (360 degrees) as shown in table III.

4.4.2.2 Alternative test procedure. Because the number of revolutions in the torsional test is proportional to the free length, the inspector may allow a free length before the test of $4 \pm 1/16$ inches for wires up to 0.040 inch in diameter or of $6 \pm 1/16$ inches for wires not more than 0.060 inch in diameter. Wire specimens with a free length of 4 inches shall not break when twisted one-half the number of revolutions shown in table III. The wire specimens with a free length of 6 inches shall not break when twisted three-fourths the number of revolutions shown in table III. Testing shall be done in the same manner as described in 4.4.2.1.

4.4.3 Wrapping test of main wires. From each short sample, not less than one specimen of each size of main wires from each wire strand shall be taken. The test specimen may be of any convenient length and shall be as unwound from a strand. One end of the specimen shall be secured on the mandrel in any convenient manner. The diameters of the mandrels and the number of wraps shall be as specified in 3.3.3.1 and 3.3.3.2 for the material and finish of the wires under the test. The wire shall not break or fracture. Occasional breakages at the place where the wire is secured on the mandrel shall be disregarded and an additional specimen substituted for the test.

4.4.4 Zinc coating test.

4.4.4.1 Weight of coating test. The zinc coating shall be tested for weight by the Hydrochloric (Muriatic) Acid-Antimony Chloride Method, also called the stripping method.

4.4.4.2 The specimens shall be cleaned with an organic solvent, rinsed in water, and dried. The surface shall be considered to be sufficiently clean when the water rinse shows freedom from "water breaks", that is, when water wets the entire surface.

4.4.4.3 Preparation of the stripping solution. Twenty grams (g) of antimony trioxide (Sb_2O_3) or 32 g of antimony trichloride (SbCl_3) shall be dissolved in 1,000 milliliters (ml) of concentrated hydrochloric acid (HCl) having a specific gravity of approximately 1.19. To prepare the zinc stripping solution, 5 ml of the received antimony trichloride solution shall be added to each 1,000 ml of concentrated hydrochloric acid (HCl) having a specific gravity of approximately 1.19.

4.4.4.4 Procedure. The specimen cleaned in accordance with 4.4.4.2 shall be weighed to the nearest 0.01 g.

a. The zinc coating shall be stripped from the weighted specimen by immersing it in the stripping solution until the evolution of hydrogen ceases, or until only a few bubbles are evolved. If the vessel used for the stripping bath is of small size, the specimen shall be loosely coiled to facilitate complete immersion. The temperature of the stripping solution shall at no time exceed 100 °F. The same solution may be repeatedly used without further additions of antimony trichloride solution, until the time for stripping becomes inconveniently long.

b. After stripping, the specimen shall be washed and scrubbed under running water and dried.

c. The weight of the stripped specimen shall be determined to the nearest 0.01 g.

d. The diameter of the stripped specimen, in inches, shall be determined by taking the mean of two measurements at right angles to each other. The measurements shall be made to the nearest 0.001 inch.

e. The weight of zinc coating shall be calculated as follows:

$$A = (W_1 - W_2)/W_2 \cdot d \cdot 163$$

Where:

A = Weight of zinc coating in ounces per square foot of stripped wire surface.

W_1 = Original weight of specimen.

W_2 = Stripped weight of specimen.

d = Diameter, in inches, of stripped wire.

163 = Constant.

4.4.5 Fabrication tests (in strands).

4.4.5.1 Determination of the number of stranding operations. The number of stranding operations in wire strands shall be determined from the short sample. One of the outside wires in the strand shall be unlaidd for a distance of 1 foot, holding the remaining outside wires in their original position. If the unlaidd wire was in contact with the same wires in the inside layer, then the two layers were fabricated in one operation. The same tests may be applied to the intermediate layers of the strand after removing all outer layer wires.

4.4.5.2 Preformed wire rope. If the seizing at one end of the wire is removed, the difference between the nominal diameter of the wire rope and the nominal diameter before seizing is removed shall be not more than the values given in table XLIX, or for type VI, small cord, wire rope, in table XLVI.

4.5 Rejection and retests.

4.5.1 Rejection. If any of the test specimens fail to pass any specified tests, all reels or coils from the same manufacturing reel or coil in the lot shall be rejected. If the test specimens were taken from each individual reel or coil, the particular reel or coil, the specimen of which failed in the tests, shall be rejected.

4.5.2 Retest. In the event of failure of one or more representative specimens, retest of additional specimens from the lot will be permitted. If one of the retest specimens fails, the lot shall be rejected with no further retesting permitted. Only one retest shall be permitted for each lot.

4.6 Inspection of packing. Sample packages and packs, and the inspection of the preservation, packaging, packing, and marking for shipment and storage shall be in accordance with the requirements of section 5 and the documents specified therein.

5. PACKAGING

(The preparation for delivery requirements specified herein applies only for direct government procurements. For the extent of applicability of the preparation for delivery requirements of referenced documents listed in section 2, (see 6.6)).

5.1 Preservation and packaging. Preservation and packaging shall be level A or C, as specified (see 6.2(gg)).

5.1.1 Level A.

5.1.1.1 Wire rope. Wire rope shall be preserved and packaged in accordance with ASTM A 700. Unless otherwise specified (see 6.2(hh)), rope shall be furnished on reels. Phosphor bronze, corrosion-resistant, and galvanized wire rope shall be packaged as specified for steel wire rope except preservative (protective) coating compounds shall not be required.

5.1.1.2 Seizing strand. Seizing strand shall be furnished on commercial type reels. Reels shall be of sufficient size and construction commensurate with the quantity of strands specified (see 6.2(hh)). Reels shall be wrapped with two thicknesses of waterproofed flexible barrier material conforming to PPP-B-1055 and secured in place with two tension tied steel bandings or wire in accordance with ASTM A 700.

5.1.2 Level C. Wire rope and seizing strand shall be preserved and packaged to afford adequate protection against corrosion, deterioration, and damage during shipment from the supply source to the first receiving activity for immediate use or controlled humidity storage. The contractor may use his standard practice when it needs these requirements.

5.2 Packing. Packing shall be level A, B, or C, as specified (see 6.2(gg)).

5.2.1 Level A.

5.2.1.1 Wire rope shall be packed in accordance with ASTM A 700.

5.2.1.2 Seizing strand reels shall be packed in unsheathed crates conforming to ASTM D 6039/D 6039M. Anchoring of contents and the closure and strapping of containers shall be in accordance with ASTM D 6039/D 6039M. Reels of the "cross-line" and "clothes-line" type may be consolidated for shipment without over-packing. In consolidation, reels in multiples of three shall be lagged together with four lagging members of nominal 1- by 4-inch lumber nailed into the ends of the cross arm members.

5.2.2 Level B.

5.2.2.1 Wire rope on reels.

5.2.2.1.1 Reels exceeding 36 inch diameter. Unless otherwise specified (see 6.2(ii)), wire rope on reels exceeding 36 inches shall be packed as specified in 5.2.1.1.

5.2.2.1.2 Reels 36 inch diameter and under. Wire rope, packaged as specified, shall be packed in accordance with ASTM A 700, level A, except that in lieu of wood lagging, the reels shall have a hardboard veneer conforming to AHA/BOARD A135.4 placed directly on top of the wire rope. This form of lagging shall extend the full inside width between the reel flanges and shall overlap a minimum of 6 inches. The lagging board shall be secured with two steel straps or wires conforming to ASTM D 3953, nailless, finish A or B, grade 2.

5.2.2.2 Seizing strand. Seizing strand shall be packed as specified in 5.2.1.2.

5.2.3 Level C. Wire rope shall be packed in a manner acceptable to the common carrier that will insure safe delivery at destination in a satisfactory condition at the lowest applicable rate.

5.2.4 Containers, packing, or method of shipment shall comply with WRA UFC 6000 or National Motor Freight Classification rules and regulations or other carrier rules as applicable to the mode of transportation.

5.3 Marking.

5.3.1 Military agencies. In addition to any special marking required by the contract or purchase order, shipments shall be marked in accordance with ASTM A 700. Unsheathed crates (see 5.2.1.2) shall be marked with "Center of Balance" and "Use No Hooks" in accordance with ASTM D 6039/D 6039M.

5.3.2 Civil agencies. Marking for shipment shall be in accordance with FED-STD-123.

6. NOTES

INFORMATION FOR GUIDANCE ONLY. (This section contains information of a general or explanatory nature that is helpful, but is not mandatory.)

6.1 Intended use. Wire rope and wire seizing strand covered by this specification are intended for use in general hauling, hoisting, lifting, transporting, well drilling, in passenger and freight elevators, and for marine mooring, towing, trawling, and similar work. (Not intended for aircraft use).

6.2 Acquisition requirements. Acquisition documents should specify the following:

- a. Title, number, revision, and date of this specification.
- b. Types, classes, construction (see 3.5), and sizes of wire rope and seizing strands required (see 1.2.1).
- c. If phosphor bronze should be other than composition A of ASTM B 139/B 139M (see 3.1.2).
- d. Diameter of wire strand centers (see 3.2.4).
- e. If other core materials are required (see 3.2.5).
- f. When wire rope should be pre-stretched (see 3.3.4).
- g. When other than uncoated carbon steel is required (see 3.3.5.1).
- h. Process of zinc coating required (see 3.3.5.2).
- i. Whether preformed or non-preformed wire ropes and strands should be supplied (see 3.4.3).
- j. If a particular construction is required (see 3.5).
- k. If uncoated iron or steel wire ropes are to be coated with a special lubricant during manufacture (see 3.6.2.1).
 - l. When no lubricant is to be applied, rust inhibitor shall be applied to the entire length of wire rope (see 3.6.2.2).
 - m. If specific lubrication is required for coated (galvanized) steel and iron, corrosion-resistant steel, and phosphor bronze wire ropes (see 3.6.3).
- n. For type I, general purpose, class 1, 6 by 7:
 - (1) Material (see 3.11.1.2).
 - (2) Finish (see 3.11.1.2.1).
 - (3) Cores (see 3.11.1.3).
 - (4) Fabrication (see 3.11.1.4).
 - (5) Lay (see 3.11.1.5).
- o. For type I, general purpose, class 2, 6 by 19:
 - (1) Material (see 3.11.2.1).
 - (2) Finish (see 3.11.2.1.1).
 - (3) Cores (see 3.11.2.1.2).
 - (4) Fabrication (see 3.11.2.1.3).
 - (5) Lay (see 3.11.2.1.4).
- p. For type I, general purpose, class 3, 6 by 37:
 - (1) Material (see 3.11.3.1).
 - (2) Finish (see 3.11.3.1.1).
 - (3) Cores (see 3.11.3.1.2).

- (4) Fabrication (see 3.11.3.1.3).
- (5) Lay (see 3.11.3.1.4).
- q. For type I, general purpose, class, 8 by 19:
 - (1) Finish (see 3.11.4.1.1).
 - (2) Cores (see 3.11.4.1.2).
 - (3) Fabrication (see 3.11.4.1.3).
- r. For type I, general purpose, class 5, 6 by 61:
 - (1) Material (see 3.11.5.1).
 - (2) Finish (see 3.11.5.1.1).
 - (3) Cores (see 3.11.5.1.2).
 - (4) Fabrication (see 3.11.5.1.3).
 - (5) Lay (see 3.11.5.1.4).
- s. For type I, general purpose, class 6, 6 by 91:
 - (1) Material (see 3.11.6.1).
 - (2) Finish (see 3.11.6.1.1).
 - (3) Cores (see 3.11.6.1.2).
 - (4) Fabrication (see 3.11.6.1.3).
 - (5) Lay (see 3.11.6.1.4).
- t. For type II, elevator:
 - (1) Material (see 3.12.1).
 - (2) Fabrication (see 3.12.1.3).
- u. For type III, marine (cables), class 1, 6 by 6 deck lashing rope:
 - (1) Finish (see 3.13.1.3).
- v. For type III, marine (cables), class 2, 6 by 12 running rope:
 - (1) Material (see 3.13.2.2).
 - (2) Fabrication (see 3.13.2.5).
- w. For type III, marine (cables), class 3, 6 by 24 mooring lines:
 - (1) Fabrication (see 3.13.3.1.3).
- x. For type III, marine (cables), class 5, 6 by 3 by 19 spring lay:
 - (1) Finish (see 3.13.5.1.1).
- y. For type III, marine (cables), class 6, 6 by 42 tiller or hand control ropes:
 - (1) Material (see 3.13.5.5.2).
 - (2) If required, finish on steel (see 3.13.5.5.2.1).
- z. For type IV, miscellaneous, class 2, 18 by 7 rotation resistant:
 - (1) Finish (see 3.14.3.1.2).
 - (2) Cores (see 3.14.3.1.3).
- aa. For type IV, miscellaneous, class 3, flattened strand:
 - (1) Cores (see 3.14.4.1.2) (For Navy aircraft elevator service, cores shall be 100 percent wire).
 - (2) Fabrication (see 3.14.4.1.3).
- bb. For type V, auxiliary wire strands:
 - (1) Material (see 3.15.1.1).
 - (2) Fabrication (see 3.15.1.3).
- cc. Type V, auxiliary wire strands, class 2, 1 by 19 seizing strand:
 - (1) Material (see 3.15.2.1).
 - (2) Fabrication (see 3.15.2.3).

- dd. Type VI, small cords:
 - (1) Material (see 3.16.1).
- ee. When tensile tests should be performed (see 4.4.1.2).
- ff. When torsion tests should be performed (see 4.4.2).
- gg. Selection of applicable levels of preservation, packaging, and packing required (see 5.1 and 5.2).
- hh. Whether rope should be furnished other than on reels (see 5.1.1.1 and 5.1.1.2).
- ii. When reels exceeding 36 inches may be packed as specified (see 5.2.2.1.1).

6.3 General rules for selection of wire ropes. Wire ropes differ by the number of strands, by the diameters, number and arrangement of wires in the strands, by the finish of the wire, and finally, by the kind of core.

6.3.1 Strength. Ropes of the same type, diameter, class, wire finish and core have the same breaking strength, regardless of their strand construction.

6.3.2 Flexibility. Ropes of the same type, class, wire finish, and core that are made of strands with greater number of wires have better flexibility.

6.3.3 Resistance to abrasion. Ropes of the same type and class that are made of strands with large diameter wires in the outer layer have longer wear resistance but less flexibility.

6.3.4 Fatigue resistance. Ropes of the same type, class, wire finish, and core will show better fatigue resistance when the strand is one operation (as in Warrington construction) and where the lang lay can be used.

6.3.5 Heat resistance. Wire ropes with wire centers in strands, with wire strand cores, or with IWRC should be used wherever a danger of drying out or charring of fibrous material in wire strand centers and wire rope cores is present, as in steel mills, coke plants, cement mills, and oil cracking plants.

6.3.6 Crushing resistance. Wire ropes of small diameter with wire strand cores and IWRC have high crushing resistance.

6.3.7 Preforming. Preforming improves fatigue resistance, flexibility, even distribution of load to every wire, and resistance to kinking.

6.3.8 Lays. The most common lay in wire ropes is the right regular lay. Left regular lay is used where the untwisting rotation of the rope will counteract the unscrewing forces in the supported load as, for example, in drill rods and tubes for well servicing.

6.3.8.1 Lang lay. Because of greater length of exposed wires, the lang lay assures longer abrasion resistance of the wires, less radial pressure on small diameter sheaves or drums by the ropes, and less bending stresses in wires than in regular lay wire ropes. Disadvantages of the lang lay are the tendency to kinking and unlaying or opening up of the strands, which is undesirable for work where grit, dust, and moisture are present.

6.3.9 Construction.

6.3.9.1 When a specific construction is not required for the intended use, construction should not be specified but should be left to the option of the contractor.

6.3.9.2 When a specific construction is required for the intended use, construction specified should fall within the size and lay type limits of the particular construction.

6.4 Definitions and terms. The following definitions and terms for wire ropes and strands are used in this specification.

6.4.1 Strength.

6.4.1.1 Nominal strength. Nominal strength is the calculated published strength values that the designer uses when making design calculations.

6.4.1.2 Breaking strength. Breaking strength is the ultimate load at which a tensile failure occurs in the sample of wire rope being tested.

6.4.1.3 Acceptance breaking strength. Acceptance breaking strength is the minimum value on which compliance with the specifications is determined.

6.4.2 Bright wires. Bright wires are wires in ropes or strands that are uncoated.

6.4.3 Center. The center is the inner or foundation member (wire or twisted fibrous material) in a strand around which the wires are laid.

6.4.4 Circumference. The circumference is the measured perimeter of a circle circumscribing the wires of a strand or the strands of a wire rope.

6.4.5 Core. The core is the foundation member (a twisted fibrous material, a wire strand, or an independent wire rope) of a wire rope around which the main strands are laid.

6.4.6 Ordered diameter. The ordered diameter of a wire rope or strand is the nominal diameter of the circumscribing circle (see figure 53).

6.4.7 Fibers. Fibers are the material of which applicable centers or cores are made.

6.4.8 Filler wires. Filler wires are small diameter wires for supporting and positioning main wires. Filler wires are included in the actual wire count and identification of the rope construction.

6.4.9 Galvanized (or coated) wire ropes and strands. Galvanized wire ropes and strands are wire ropes or strands made of zinc coated (galvanized) wires.

6.4.10 Galvanized (zinc coated) wires. In the manufacture of galvanized rope wire, the wire is zinc coated at finished size. In the manufacture of drawn galvanized rope wire, the wire is zinc coated before the last drawing operation. The zinc coating may be by either the hot-dip process or by the electro-deposition process. Galvanized rope wire has 10 percent less tensile strength than uncoated rope wire; drawn galvanized rope wire has the same strength as uncoated rope wire.

6.4.11 Independent wire rope core (IWRC). IWRC is a complete small diameter wire rope used as a core in a larger wire rope.

6.4.12 Lay. The word "lay" is used by the wire rope industry in two different ways as follows:

a. The lay is the manner in which the wires in a strand or the strands in a wire rope are twisted (see figure 4).

b. The lay is the distance parallel to the longitudinal axis in which a wire makes a complete turn (spiral or helix) about the axis of the strand, or a strand about the axis of the rope. It is also called the lay length or the pitch.

6.4.12.1 Pitch (lay length). See 6.4.12(b).

6.4.13 Lang lay (see 6.4.12(a) and figure 4). In a lang lay wire rope, the direction of lay of the wires in the strand and of the strand in the rope is the same. As a result, the rope has an appearance that the wires are diagonal to the axis of the rope. The wires and the strands may run to the right, right lang lay (commonly called lang lay), or to the left, left lang lay (on specific orders only).

6.4.14 Regular lay. In a regular lay rope, the wires in the rope strand lay in one direction while the strand in the rope lay in an opposite direction. The rope therefore has an outward appearance that all wires in the rope are roughly parallel to the longitudinal axis of the rope. There are two regular lays as follows:

a. Right regular lay (commonly called regular lay). The strands run in the rope downward to the right (clockwise) while the wires in the strands run to the left (counterclockwise). This is the most used lay.

b. Left regular lay. The strands in the rope run downward to the left (counterclockwise) while the wires in the strand run to the right (clockwise) (see figure 4). The attachment point on the drum flange for securing the bitter end of left regular lay rope is the mirror image of the standard wire rope installation using right regular lay. Only in special cases should left regular lay rope be used and it must be specifically ordered.

6.4.15 Marline clad rope. A rope in which the strands are covered by a layer of tarred fibrous material wound to protect the hands, to cushion the strands in the rope, and to protect them against wear.

6.4.16 Preformed strand. A strand in which the wires are permanently shaped to the spiral form they assume in the strand.

6.4.17 Preformed wire rope. A wire rope in which the strands are permanently shaped to the spiral form they assume in the wire rope.

6.4.18 Reels, manufacturing. Manufacturing or master reels are the reels on which the strands and the wire ropes are wound in one continuous length as they are formed on the closing machines.

6.4.19 Reels, shipping. Reels on which wire strands or wire ropes, cut to the ordered lengths, are wound from the manufacturing reel for shipment.

6.4.20 Brangle. A brangled strand is one that is shaped after fabrication (for example, triangular) by rollers or by other mechanical means.

6.4.21 Strand classification. The strand classification covered by the various rope classes are defined as follows:

a. 7-wire classification -- a strand having 3 through 14 wires, but not more than 9 outer wires in the strand.

b. 19-wire classification -- a strand having 15 through 26 wires but not more than 12 outer wires in the strand.

c. 37-wire classification -- a strand having 27 through 49 wires but not more than 18 outer wires in the strand.

d. 61-wire classification -- a strand having 50 through 74 wires but not more than 24 outer wires in the strand.

e. 91-wire classification -- a strand having 75 and more wires but not more than 30 outer wires in the strand.

6.5 These specifications and testing procedures set forth in this document are applicable to wire rope made or manufactured pursuant to government order only and not intended to apply to rope made or manufactured for any other purchaser.

6.6 Sub-contracted material and parts. The preparation for delivery requirements of referenced documents listed in section 2 do not apply when material and parts are procured by the contractor for incorporation into the equipment and lose their separate identity when the equipment is shipped.

6.7 Subject term (key word) listing.

cable	mooring line
elevator	right lang lay
fiber core	right regular lay
lashing rope	running ropes
left lang lay	seizing strand
left regular lay	spring lay
marine	zinc coated

6.8 Changes from previous issue. Asterisks are not used in this revision to identify changes with respect to the previous issue due to the extent of the changes.

6.9 Part or identification number (PIN).

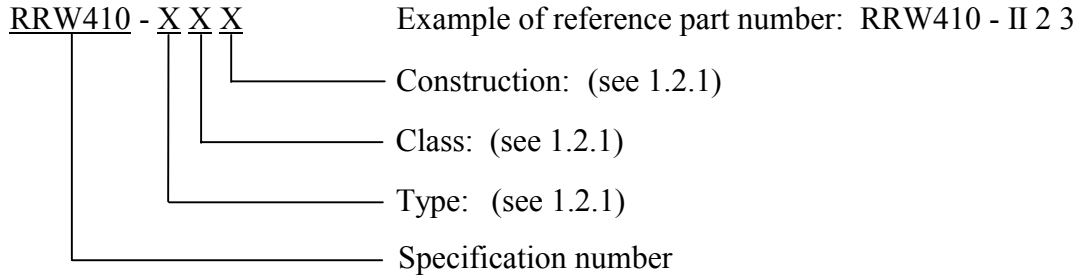

RRW410 - II 2 3 indicates: type II - elevator; class 2 - 8 by 19; construction 3 - 8 by 19 Seale.

TABLE I. Tensile strength requirements of main wires removed from finished rope.

Material	Tensile strength (minimum)	
	Uncoated or drawn galvanized (lb./in. ²)	Galvanized at finish size (lb./in. ²)
Designated commercially as:		
Iron	70,000	55,000
Annealed steel	---	60,000
Traction steel	160,000	---
Improved plow steel:		
0.030 inch diameter and smaller	244,000	219,000
0.030 - 0.060 inch	238,000	214,000
0.061 - 0.100 inch	230,000	207,000
0.101 - 0.140 inch	225,000	202,000
0.141 - 0.190 inch	218,000	196,000
0.191 - 0.250 inch	209,000	---
Extra improved plow steel:		
0.030 inches diameter and smaller	268,000	---
0.031 - 0.060 inch	262,000	---
0.060 - 0.100 inch	253,000	---
0.101 - 0.140 inch	248,000	---
0.141 - 0.190 inch	240,000	---
0.191 - 0.250 inch	230,000	---
Phosphor bronze	90,000	---
Corrosion resistant steel	205,000	---

TABLE II. Weight of zinc coating in rope and strand wires removed from finished rope.

Galvanized at finish size		Drawn galvanized wire	
Wire diameter (inch)	Minimum weight of zinc coating (ounce per square foot)	Wire diameter (inch)	Minimum weight of zinc coating (ounce per square foot)
0.010 - 0.015	0.05	0.010 - 0.015	0.05
0.0155 - 0.027	0.10	Over 0.015 - 0.028	0.10
0.028 - 0.047	0.20	Over 0.028 - 0.060	0.20
0.048 - 0.054	0.40	Over 0.060 - 0.090	0.30
0.055 - 0.063	0.50	Over 0.090 - 0.140	0.40
0.064 - 0.079	0.60		
0.080 - 0.092	0.70		
0.093 - larger	0.80		

TABLE III. Torsion values for bright (uncoated) and drawn-galvanized main wires removed from finished rope.

Material	Torsion (revolutions) per 100 wire diameters in length ¹
Extra improved plow steel	27.0 - 100 d ²
Improved plow steel	28.0 - 25 d ²
Traction steel	30.5 - 25 d ²

¹To convert to torsions in 8 inches, divide torsions in 100 d by 12.5 d.

²d - diameter of wire. Zinc coated (galvanized) at finish size main wires will not be required to meet these torsion values.

TABLE IV. Permissible variations in wire diameters of one diameter wires removed from finished ropes.

Wire diameters (inch)	Uncoated (bright) and drawn-galvanized wires (inch)	Zinc coated at finish size (inch)
0.010 - 0.027	0.0015	--
0.028 - 0.059	0.002	0.0035
0.060 - 0.092	0.0025	0.0045
0.093 - 0.141	0.003	0.0055
0.142 - 0.200	0.0035	0.0075
0.201 - 0.250	0.004	0.0095

TABLE V. Rope or strand diameters for all ropes except type II elevator, type III spring lay, type IV, 5 by 19 marline clad, type V, seizing strand, and type VI, small cords.

Rope diameter (inch)	Tolerance (percent)	
	Under	Over ¹
3/16	0	7
7/32	0	6
1/4	0	6
5/16	0	6
3/8 and larger	0	5

¹A question may develop as to whether or not the wire rope complies with the oversize tolerance. In such cases, a tension of not less than 10 percent nor more than 20 percent of nominal required breaking strength is applied to the rope and the rope again measured while under this tension.

TABLE VI. Rope diameters for type VI small cords.

Rope diameter (inch)	Tolerance (inch)	
	Under	Over
1/32	0	0.006
3/64	0	0.008
1/16	0	0.010
3/32	0	0.012
1/8	0	0.014
5/32	0	0.016
3/16	0	0.018
7/32	0	0.018
1/4	0	0.018
9/32	0	0.020
5/16	0	0.022
3/8	0	0.026

TABLE VII. Type I, general purpose, class 1, 6 by 7, improved plow steel, fiber cores.

Rope diameter		Approximate circumference (inches)	Maximum strand pitch			Approx. weight (lb./ft.)	Uncoated		Galvanized	
Nominal (ordered) (minimum) (inches)	Max. (inches)		Regular lay		Lang lay		Nominal strength (lb.)	Acceptance breaking strength (lb.)	Nominal strength (lb.)	Acceptance breaking strength (lb.)
			Uncoated (inches)	Galvanized (inches)	Uncoated (inches)					
1/4	0.265	3/4	1 3/4	2	1 7/8	0.094	5,280	5,140	4,760	4,640
5/16	0.328	1	2 3/16	2 1/2	2 11/32	0.15	8,200	8,000	7,380	7,200
3/8	0.394	1 1/8	2 5/8	3	2 13/16	0.21	11,720	11,420	10,540	10,280
7/16	0.459	1 3/8	3 1/16	3 1/2	3 9/32	0.29	15,860	15,460	14,280	13,920
1/2	0.525	1 5/8	3 1/2	4	3 3/4	0.38	20,600	20,000	18,540	18,080
9/16	0.591	1 3/4	3 15/16	4 1/2	4 7/32	0.48	26,000	25,400	23,400	22,800
5/8	0.656	2	4 3/8	5	4 11/16	0.59	31,800	31,000	28,600	27,800
3/4	0.788	2 3/8	5 1/4	6	5 5/8	0.84	45,400	44,200	40,800	39,800
7/8	0.919	2 3/4	6 1/8	7	6 9/16	1.15	61,400	59,800	55,200	53,800
1	1.050	3 1/8	7	8	7 1/2	1.50	79,400	77,400	71,400	69,600
1 1/8	1.181	3 1/2	7 7/8	9	8 7/16	1.90	99,600	97,200	89,600	87,400
1 1/4	1.313	3 7/8	8 3/4	10	9 3/8	2.34	122,000	119,000	109,800	107,000
1 3/8	1.444	4 3/8	9 5/8	11	10 5/16	2.84	146,200	142,600	131,600	128,400
1 1/2	1.575	4 3/4	10 1/2	12	11 1/4	3.38	172,400	168,000	155,200	151,400

TABLE VIII. Type I, general purpose, class 1, 6 by 7, iron galvanized, regular lay, fiber cores.

Rope diameter		Approximate circumference (inches)	Maximum strand pitch (inches)	Approximate weight (lb./ft.)	Nominal strength (lb.)	Acceptance breaking strength (lb.)
Nominal (ordered) (maximum) (inches)	Maximum (inches)					
1/4	0.265	3/4	2	0.094	1,840	1,800
5/16	0.328	1	2 1/2	0.15	2,840	2,760
3/8	0.394	1 1/8	3	0.21	4,080	3,980
7/16	0.459	1 3/8	3 1/2	0.29	5,520	5,380
1/2	0.525	1 5/8	4	0.38	7,160	6,980
9/16	0.591	1 3/4	4 1/2	0.48	9,020	8,800
5/8	0.656	2	5	0.59	11,080	10,800
3/4	0.788	2 3/8	6	0.84	15,800	15,400
13/16	0.853	2 1/2	6 1/2	0.99	18,460	18,000
7/8	0.919	2 3/4	7	1.15	21,400	20,800
1	1.050	3 1/8	8	1.50	27,600	27,000
1 1/16	1.116	3 3/8	8 1/2	1.70	31,000	30,200
1 1/8	1.181	3 1/2	9	1.90	34,600	33,800
1 3/16	1.247	3 3/4	9 1/2	2.12	38,400	37,400
1 1/4	1.313	3 7/8	10	2.34	42,400	41,400

TABLE IX. Core materials.

Material	Core
Extra improved plow steel	Wire strand core or IWRC
Improved plow steel	Fiber core, wire strand core or IWRC
Corrosion-resistant steel	Wire strand core or IWRC
Phosphor bronze	Fiber core

TABLE X. Type I, general purpose, class 2, 6 by 19, and class 3, 6 by 37, single operation strand, improved plow steel, fiber cores.

Rope diameter		Approximate circumference (inches)	Maximum strand pitch		Approximate weight (lb./ft.)	Uncoated		Galvanized	
Nominal (ordered) (minimum) (inches)	Maximum (inches)		Uncoated regular lay (inches)	Uncoated lang lay or galvanized regular lay (inches)		Nominal strength (lb.)	Acceptance breaking strength (lb.)	Nominal strength (lb.)	Acceptance breaking strength (lb.)
1/4	0.265	3/4	1 11/16	1 13/16	0.105	5,480	5,340	4,940	4,820
5/16	0.328	1	2 1/8	2 9/32	0.164	8,520	8,300	7,660	7,460
3/8	0.394	1 1/8	2 17/32	2 23/32	0.236	12,200	11,900	10,980	10,700
7/16	0.459	1 3/8	2 31/32	3 3/16	0.32	16,540	16,120	14,880	14,500
1/2	0.525	1 5/8	3 3/8	3 5/8	0.42	21,400	20,800	19,260	18,780
9/16	0.591	1 3/4	3 13/16	4 3/32	0.53	27,000	26,400	24,300	23,800
5/8	0.656	2	4 7/32	4 17/32	0.66	33,400	32,600	30,000	29,200
3/4	0.788	2 3/8	5 1/16	5 7/16	0.95	47,600	46,400	42,800	41,800
7/8	0.919	2 3/4	5 29/32	6 11/32	1.29	64,400	62,800	58,000	56,600
1	1.050	3 1/8	6 3/4	7 1/4	1.68	83,600	81,600	75,200	73,400
1 1/8	1.181	3 1/2	7 19/32	8 5/32	2.13	105,200	102,600	94,600	92,200
1 1/4	1.313	3 7/8	8 7/16	9 1/16	2.63	129,200	126,000	116,200	113,200
1 3/8	1.444	4 3/8	9 9/32	9 31/32	3.18	155,400	151,600	139,800	136,400
1 1/2	1.575	4 3/4	10 1/8	10 7/8	3.78	184,000	179,400	165,600	161,400
1 5/8	1.706	5 1/8	10 31/32	11 25/32	4.44	214,000	208,000	192,600	187,800
1 3/4	1.838	5 1/2	11 13/16	12 11/16	5.15	248,000	242,000	224,000	218,000
1 7/8	1.969	5 7/8	12 21/32	13 19/32	5.91	282,000	274,000	254,000	248,000
2	2.100	6 1/4	13 1/2	14 1/2	6.72	320,000	312,000	288,000	280,000
2 1/8	2.231	6 5/8	14 11/32	15 13/32	7.59	358,000	350,000	322,000	314,000
2 1/4	2.363	7 1/8	15 3/16	16 5/16	8.51	400,000	390,000	360,000	351,000
2 1/2	2.625	7 7/8	16 7/8	18 1/8	10.5	488,000	476,000	440,000	429,000
2 3/4	2.888	8 5/8	18 9/16	19 15/16	12.7	584,000	570,000	526,000	512,000
3	3.150	9 3/8	20 1/4	21 3/4	15.1	685,000	668,000	616,000	601,000
3 1/4	3.413	10 1/4	21 15/16	23 9/16	17.7	798,000	778,000	718,000	700,000
3 1/2	3.675	11	23 5/8	25 3/8	20.6	914,000	892,000	822,000	802,000

TABLE XI. Type I, general purpose, class 2, 6 by 19, and class 3, 6 by 37, single operation strand, improved plow steel, wire strand core or IWRC.

Rope diameter		Approximate circumference (inches)	Maximum strand pitch		Approximate weight (lb./ft.)	Uncoated		Galvanized	
Nominal (ordered) (minimum) (inches)	Maximum (inches)		Uncoated regular lay (inches)	Uncoated lang lay or galvanized regular lay (inches)		Nominal strength (lb.)	Acceptance breaking strength (lb.)	Nominal strength (lb.)	Acceptance breaking strength (lb.)
1/4	0.265	3/4	1 11/16	1 13/16	0.116	5,880	5,740	5,300	5,160
5/16	0.328	1	2 1/8	2 9/32	0.180	9,160	8,940	8,240	8,040
3/8	0.394	1 1/8	2 17/32	2 23/32	0.26	13,120	12,800	11,800	11,500
7/16	0.459	1 3/8	2 31/32	3 3/16	0.35	17,780	17,340	16,000	15,600
1/2	0.525	1 5/8	3 3/8	3 5/8	0.46	23,000	22,400	20,700	20,200
9/16	0.591	1 3/4	3 13/16	4 3/32	0.59	29,000	28,200	26,100	25,400
5/8	0.656	2	4 7/32	4 17/32	0.72	35,800	35,000	32,200	31,400
3/4	0.788	2 3/8	5 1/16	5 7/16	1.04	51,200	50,000	46,000	44,800
7/8	0.919	2 3/4	5 29/32	6 11/32	1.42	69,200	67,400	62,200	60,600
1	1.050	3 1/8	6 3/4	7 1/4	1.85	89,800	87,600	80,800	78,800
1 1/8	1.181	3 1/2	7 19/32	8 5/32	2.34	113,000	110,200	101,800	99,200
1 1/4	1.313	3 7/8	8 7/16	9 1/16	2.89	138,800	135,400	125,000	121,800
1 3/8	1.444	4 3/8	9 9/32	9 31/32	3.50	167,000	162,800	150,400	146,600
1 1/2	1.575	4 3/4	10 1/8	10 7/8	4.16	197,800	192,800	178,000	173,600
1 5/8	1.706	5 1/8	10 31/32	11 25/32	4.88	230,000	224,000	207,000	202,000
1 3/4	1.838	5 1/2	11 13/16	12 11/16	5.67	266,000	260,000	240,000	234,000
1 7/8	1.969	5 7/8	12 21/32	13 19/32	6.50	304,000	296,000	274,000	268,000
2	2.100	6 1/4	13 1/2	14 1/2	7.39	344,000	336,000	310,000	302,000
2 1/8	2.231	6 5/8	14 11/32	15 13/32	8.35	384,000	374,000	346,000	338,000
2 1/4	2.363	7 1/8	15 3/16	16 5/16	9.36	430,000	420,000	387,000	378,000
2 1/2	2.625	7 7/8	16 7/8	18 1/8	11.6	524,000	511,000	472,000	460,000
2 3/4	2.888	8 5/8	18 9/16	19 15/16	14.0	628,000	612,000	566,000	552,000
3	3.150	9 3/8	20 1/4	21 3/4	16.6	740,000	722,000	666,000	650,000
3 1/4	3.413	10 1/4	21 15/16	23 9/16	19.5	858,000	836,000	772,000	752,000
3 1/2	3.675	11	23 5/8	25 3/8	22.7	982,000	958,000	884,000	862,000

TABLE XII. Type I, general purpose, class 2, 6 by 19, and class 3, 6 by 37, single operation strand, extra improved plow steel, wire strand core or IWRC.

Rope diameter		Approximate circumference (inches)	Maximum strand pitch		Approximate weight (lb./ft.)	Uncoated		Galvanized	
Nominal (ordered) (minimum) (inches)	Maximum (inches)		Uncoated regular lay (inches)	Uncoated lang lay or galvanized regular lay (inches)		Nominal strength (lb.)	Acceptance breaking strength (lb.)	Nominal strength (lb.)	Acceptance breaking strength (lb.)
1/4	0.265	3/4	1 11/16	1 13/16	0.116	6,800	6,640	6,120	5,960
5/16	0.328	1	2 1/8	2 9/32	0.180	10,540	10,280	9,480	9,240
3/8	0.394	1 1/8	2 17/32	2 23/32	0.26	15,100	14,720	13,600	13,260
7/16	0.459	1 3/8	2 31/32	3 3/16	0.35	20,400	19,900	18,360	17,900
1/2	0.525	1 5/8	3 3/8	3 5/8	0.46	26,600	26,000	24,000	23,400
9/16	0.591	1 3/4	3 13/16	4 3/32	0.59	33,600	32,800	30,200	29,400
5/8	0.656	2	4 7/32	4 17/32	0.72	41,200	40,200	37,000	36,000
3/4	0.788	2 3/8	5 1/16	5 7/16	1.04	58,800	57,400	53,000	51,600
7/8	0.919	2 3/4	5 29/32	6 11/32	1.42	79,600	77,600	71,600	69,800
1	1.050	3 1/8	6 3/4	7 1/4	1.85	103,400	100,800	93,000	90,600
1 1/8	1.181	3 1/2	7 19/32	8 5/32	2.34	130,000	126,800	117,000	114,000
1 1/4	1.313	3 7/8	8 7/16	9 1/16	2.89	159,800	155,800	143,800	140,200
1 3/8	1.444	4 3/8	9 9/32	9 31/32	3.50	192,000	187,200	172,800	168,400
1 1/2	1.575	4 3/4	10 1/8	10 7/8	4.16	228,000	222,000	206,000	200,000
1 5/8	1.706	5 1/8	10 31/32	11 25/32	4.88	264,000	258,000	238,000	232,000
1 3/4	1.838	5 1/2	11 13/16	12 11/16	5.67	306,000	298,000	276,000	268,200
1 7/8	1.969	5 7/8	12 21/32	13 19/32	6.50	348,000	340,000	314,000	306,000
2	2.100	6 1/4	13 1/2	14 1/2	7.39	396,000	386,000	356,000	347,000
2 1/8	2.231	6 5/8	14 11/32	15 13/32	8.35	442,000	431,000	398,000	388,000
2 1/4	2.363	7 1/8	15 3/16	16 5/16	9.36	494,000	482,000	444,000	434,000
2 1/2	2.625	7 7/8	16 7/8	18 1/8	11.6	604,000	589,000	544,000	530,000
2 3/4	2.888	8 5/8	18 9/16	19 15/16	14.0	722,000	704,000	650,000	634,000
3	3.150	9 3/8	20 1/4	21 3/4	16.6	850,000	828,000	765,000	745,000
3 1/4	3.473	10 1/4	21 15/16	23 9/16	19.5	984,000	960,000	886,000	864,000
3 1/2	3.675	11	23 5/8	25 3/8	22.7	1,128,000	1,100,000	1,016,000	990,000

TABLE XIII. Type I, general purpose, class 2, 6 by 19, and class 3, 6 by 37, single operation strand, corrosion-resistant steel, IWRC.

Rope diameter		Approximate circumference (inches)	Maximum strand pitch		Approximate weight (lb./ft.)	Nominal strength (lb.)	Acceptance breaking strength (lb.)
Nominal (ordered) (minimum) (inches)	Maximum (inches)		Regular lay (inches)	Lang lay (inches)			
7/16	0.459	1 3/8	2 31/32	3 3/16	0.35	16,300	15,900
1/2	0.525	1 5/8	3 3/8	3 5/8	0.46	22,800	22,200
9/16	0.591	1 3/4	3 13/16	4 3/32	0.59	28,500	27,800
5/8	0.656	2	4 7/32	4 17/32	0.72	35,000	34,100
3/4	0.788	2 3/8	5 1/16	5 7/16	1.04	49,600	48,400
7/8	0.919	2 3/4	5 29/32	6 11/32	1.42	66,500	64,800
1	1.050	3 1/8	6 3/4	7 1/4	1.85	85,400	83,300
1 1/8	1.181	3 1/2	7 19/32	8 5/32	2.34	106,400	103,700
1 1/4	1.313	3 7/8	8 7/16	9 1/16	2.89	129,400	126,200
1 3/8	1.444	4 3/8	9 9/32	9 31/32	3.50	153,600	149,800
1 1/2	1.575	4 3/4	10 1/8	10 7/8	4.16	180,500	176,000

TABLE XIV. Type I, general purpose, class 2, 6 by 19, phosphor bronze, regular lay, fiber cores.

Rope diameter		Approximate circumference (inches)	Maximum strand pitch (inches)	Approximate weight (lb./ft.)	Nominal strength (lb.)	Acceptance breaking strength (lb.)
Nominal (ordered) (minimum) (inch)	Maximum (inch)					
3/16	0.201	5/8	1 9/32	0.06	1,370	1,340
7/32	0.232	11/16	1 1/2	0.09	1,830	1,780
1/4	0.265	3/4	1 11/16	0.11	2,380	2,320
5/16	0.328	1	2 1/8	0.18	3,680	3,580
3/8	0.394	1 1/8	2 17/32	0.25	5,240	5,100
7/16	0.459	1 3/8	2 31/32	0.34	7,080	6,900
1/2	0.525	1 5/8	3 3/8	0.45	9,220	8,980
9/16	0.591	1 3/4	3 13/16	0.57	11,500	11,220
5/8	0.656	2	4 7/32	0.70	14,160	13,800
3/4	0.788	2 3/8	5 1/16	1.01	19,960	19,460

TABLE XV. Type I, general purpose, class 3, construction 1, 2, or 3, 6 by 37, multiple operation strand, improved plow steel, fiber cores.

Rope diameter		Approximate circumference (inches)	Maximum strand pitch		Approximate weight (lb./ft.)	Uncoated		Galvanized	
Nominal (ordered) (minimum) (inch)	Maximum (inches)		Uncoated regular lay (inches)	Galvanized regular lay (inches)		Nominal strength (lb.)	Acceptance breaking strength (lb.)	Nominal strength (lb.)	Acceptance breaking strength (lb.)
1/4	0.265	3/4	1 11/16	1 13/16	0.105	5,180	5,060	4,660	4,540
5/16	0.328	1	2 1/8	2 9/32	0.164	8,060	7,860	7,260	7,080
3/8	0.394	1 1/8	2 17/32	2 23/32	0.236	11,540	11,260	10,380	10,120
7/16	0.459	1 3/8	2 31/32	3 3/16	0.32	15,640	15,240	14,080	13,720
1/2	0.525	1 5/8	3 3/8	3 5/8	0.42	20,400	19,900	18,360	17,900
9/16	0.591	1 3/4	3 13/16	4 3/32	0.53	25,800	25,200	23,200	22,600
5/8	0.656	2	4 7/32	4 17/32	0.66	31,600	30,800	28,400	27,600
3/4	0.788	2 3/8	5 1/16	5 7/16	0.95	45,200	44,000	40,600	39,600
7/8	0.919	2 3/4	5 29/32	6 11/32	1.29	61,200	59,600	55,000	53,600
1	1.050	3 1/8	6 3/4	7 1/4	1.68	79,600	77,600	71,600	69,800

TABLE XVI. Type I, general purpose, class 3, construction 1, 2, or 3, 6 by 37, multiple operation strand, improved plow steel, wire strand core or IWRC.

Rope diameter		Approximate circumference (inches)	Maximum strand pitch		Approximate weight (lb./ft.)	Uncoated		Galvanized	
Nominal (ordered) (minimum) (inches)	Maximum (inches)		Uncoated regular lay (inches)	Galvanized regular lay (inches)		Nominal strength (lb.)	Acceptance breaking strength (lb.)	Nominal strength (lb.)	Acceptance breaking strength (lb.)
1/4	0.265	3/4	1 11/16	1 13/16	0.116	5,560	5,420	5,000	4,880
5/16	0.328	1	2 1/8	2 9/32	0.180	8,660	8,440	7,800	7,600
3/8	0.394	1 1/8	2 17/32	2 23/32	0.26	12,400	12,100	11,160	10,880
7/16	0.459	1 3/8	2 31/32	3 3/16	0.35	16,820	16,400	15,140	14,760
1/2	0.525	1 5/8	3 3/8	3 5/8	0.46	22,000	21,400	19,800	19,300
9/16	0.591	1 3/4	3 13/16	4 3/32	0.59	27,800	27,200	25,000	24,400
5/8	0.656	2	4 7/32	4 17/32	0.72	34,000	33,200	30,600	29,800
3/4	0.788	2 3/8	5 1/16	5 7/16	1.04	48,600	47,400	43,800	42,800
7/8	0.919	2 3/4	5 29/32	6 11/32	1.42	65,800	64,200	59,200	57,800
1	1.050	3 1/8	6 3/4	7 1/4	1.85	85,600	83,400	77,000	75,000

TABLE XVII. Type I, general purpose, class 3, construction 1, 2, or 3, 6 by 37, multiple operation strand, extra improved plow steel, wire strand core or IWRC.

Rope diameter		Approximate circumference (inches)	Maximum strand pitch		Approximate weight (lb./ft.)	Uncoated		Galvanized	
Nominal (ordered) (minimum) (inch)	Maximum (inches)		Uncoated regular lay (inches)	Galvanized regular lay (inches)		Nominal strength (lb.)	Acceptance breaking strength (lb.)	Nominal strength (lb.)	Acceptance breaking strength (lb.)
1/4	0.265	3/4	1 11/16	1 13/16	0.116	6,400	6,240	5,760	5,600
5/16	0.328	1	2 1/8	2 9/32	0.180	9,960	9,720	8,960	8,740
3/8	0.394	1 1/8	2 17/32	2 23/32	0.26	14,280	13,920	12,860	12,540
7/16	0.459	1 3/8	2 31/32	3 3/16	0.35	19,340	18,860	17,400	16,960
1/2	0.525	1 5/8	3 3/8	3 5/8	0.46	25,200	24,600	22,600	22,000
9/16	0.591	1 3/4	3 13/16	4 3/32	0.59	31,800	31,000	28,600	27,800
5/8	0.656	2	4 7/32	4 17/32	0.72	39,200	38,200	35,200	34,400
3/4	0.788	2 3/8	5 1/16	5 7/16	1.04	55,800	54,400	50,200	49,000
7/8	0.919	2 3/4	5 29/32	6 11/32	1.42	75,600	73,800	68,000	66,400
1	1.050	3 1/8	6 3/4	7 1/4	1.85	98,200	95,800	88,400	86,200

TABLE XVIII. Type I, general purpose, class 3, construction 2 or 3, multiple operation strand, 6 by 37, corrosion-resistant steel, IWRC.

Rope diameter		Approximate circumference (inches)	Maximum strand pitch		Approximate weight (lb./ft.)	Nominal strength (lb.)	Acceptance breaking strength (lb.)
Nominal (ordered) (minimum) (inches)	Maximum (inches)		Regular lay (inches)	Lang lay (inches)			
7/16	0.459	1 3/8	2 31/32	3 3/16	0.35	15,800	15,400
1/2	0.525	1 5/8	3 3/8	3 5/8	0.46	20,400	19,900
9/16	0.591	1 3/4	3 13/16	4 3/32	0.59	25,500	24,900
5/8	0.656	2	4 7/32	4 17/32	0.72	31,300	30,500
3/4	0.788	2 3/8	5 1/16	5 7/16	1.04	44,400	43,300
7/8	0.919	2 3/4	5 29/32	6 11/32	1.42	59,700	58,200
1	1.050	3 1/8	6 3/4	7 1/4	1.85	77,300	75,400

TABLE XIX. Type I, general purpose, class 4, 8 by 19, improved plow steel, fiber cores.

Rope diameter		Approximate circumference (inches)	Maximum strand pitch		Approximate weight Fiber core (lb./ft.)	Uncoated		Galvanized	
Nominal (ordered) (minimum) (inches)	Maximum (inches)		Uncoated (inches)	Galvanized (inches)		Nominal strength (lb.)	Acceptance breaking strength (lb.)	Nominal strength (lb.)	Acceptance breaking strength (lb.)
1/4	0.265	3/4	1 11/16	1 13/16	0.098	4,700	4,580	4,240	4,140
5/16	0.328	1	2 1/8	2 9/32	0.15	7,300	7,120	6,580	6,420
3/8	0.394	1 1/8	2 17/32	2 23/32	0.22	10,480	10,220	9,440	9,200
7/16	0.459	1 3/8	2 31/32	3 3/16	0.30	14,180	13,820	12,760	12,440
1/2	0.525	1 5/8	3 3/8	3 5/8	0.39	18,460	18,000	16,620	16,200
9/16	0.591	1 3/4	3 13/16	4 3/32	0.50	23,200	22,600	20,800	20,200
5/8	0.656	2	4 7/32	4 17/32	0.61	28,600	27,800	25,800	25,200
3/4	0.788	2 3/8	5 1/16	5 7/16	0.88	41,000	40,000	37,000	36,000
7/8	0.919	2 3/4	5 29/32	6 11/32	1.20	55,400	54,000	49,800	48,600
1	1.050	3 1/8	6 3/4	7 1/4	1.57	72,000	70,200	64,800	63,200
1 1/8	1.181	3 1/2	7 19/32	8 5/32	1.99	90,600	88,400	81,600	79,600
1 1/4	1.313	3 7/8	8 7/16	9 1/16	2.45	111,400	108,600	100,20	97,600
1 3/8	1.444	4 3/8	9 9/32	9 31/32	2.97	134,200	130,800	120,80	117,800
1 1/2	1.575	4 3/4	10 1/8	10 7/8	3.53	158,800	154,800	143,00	139,400

TABLE XX. Type I, general purpose, class 5, 6 by 61, improved plow steel, fiber cores.

Rope diameter		Approximate circumference (inches)	Maximum strand pitch		Approximate weight (lb./ft.)	Uncoated		Galvanized	
Nominal (ordered) (minimum) (inches)	Maximum (inches)		Uncoated regular lay (inches)	Uncoated lang lay or galvanized regular lay (inches)		Nominal strength (lb.)	Acceptance breaking strength (lb.)	Nominal strength (lb.)	Acceptance breaking strength (lb.)
2	2.100	6 1/4	13 1/2	14 1/2	6.72	308,000	300,000	278,000	272,000
2 1/8	2.231	6 5/8	14 11/32	15 13/32	7.59	346,000	338,000	312,000	304,000
2 1/4	2.363	7 1/8	15 3/16	16 5/16	8.51	386,000	376,000	348,000	340,000
2 1/2	2.625	7 7/8	16 7/8	18 1/8	10.5	472,000	460,000	424,000	414,000
2 3/4	2.888	8 5/8	18 9/16	19 15/16	12.7	568,000	554,000	512,000	500,000
3	3.150	9 3/8	20 1/4	21 3/4	15.1	670,000	654,000	603,000	588,000
3 1/4	3.413	10 1/4	21 15/16	23 9/16	17.7	780,000	760,000	702,000	684,000
3 1/2	3.675	11	23 5/8	25 3/8	20.6	898,000	876,000	808,000	788,000
3 3/4	3.938	11 3/4	25 5/16	27 3/16	23.6	1,022,000	996,000	920,000	896,000
4	4.200	12 1/2	27	29	26.9	1,154,000	1,126,000	1,038,000	1,012,000
4 1/4	4.463	13 3/8	28 11/16	30 13/16	30.3	1,292,000	1,260,000	1,162,000	1,132,000
4 1/2	4.725	14 1/8	30 3/8	32 5/8	34.0	1,438,000	1,402,000	1,294,000	1,262,000
4 3/4	4.988	15	32 1/16	34 7/16	37.9	1,588,000	1,548,000	1,430,000	1,394,000
5	5.250	15 3/4	33 3/4	36 1/4	42.0	1,744,000	1,700,000	1,570,000	1,530,000

TABLE XXI. Type I, general purpose, class 5, 6 by 61, improved plow steel, wire strand core or IWRC.

Rope diameter		Approximate circumference (inches)	Maximum strand pitch		Approximate weight (lb./ft.)	Uncoated		Galvanized	
Nominal (ordered) (minimum) (inches)	Maximum (inches)		Uncoated regular lay (inches)	Uncoated lang lay or galvanized regular lay (inches)		Nominal strength (lb.)	Acceptance breaking strength (lb.)	Nominal strength (lb.)	Acceptance breaking strength (lb.)
2	2.100	6 1/4	13 1/2	14 1/2	7.39	330,000	322,000	297,000	290,000
2 1/8	2.231	6 5/8	14 11/32	15 13/32	8.35	372,000	362,000	334,000	326,000
2 1/4	2.363	7 1/8	15 3/16	16 5/16	9.36	414,000	404,000	372,000	362,000
2 1/2	2.625	7 7/8	16 7/8	18 1/8	11.6	508,000	496,000	458,000	446,000
2 3/4	2.888	8 5/8	18 9/16	19 15/16	14.0	610,000	594,000	549,000	536,000
3	3.150	9 3/8	20 1/4	21 3/4	16.6	720,000	702,000	648,000	632,000
3 1/4	3.413	10 1/4	21 15/16	23 9/16	19.5	838,000	818,000	754,000	736,000
3 1/2	3.675	11	23 5/8	25 3/8	22.7	966,000	942,000	870,000	848,000
3 3/4	3.938	11 3/4	25 5/16	27 3/16	26.0	1,098,000	1,070,000	988,000	964,000
4	4.200	12 1/2	27	29	29.6	1,240,000	1,210,000	1,116,000	1,088,000
4 1/4	4.463	13 3/8	28 11/16	30 13/16	33.3	1,388,000	1,354,000	1,250,000	1,218,000
4 1/2	4.725	14 1/8	30 3/8	32 5/8	37.4	1,544,000	1,506,000	1,390,000	1,356,000
4 3/4	4.988	15	32 1/16	34 7/16	41.7	1,706,000	1,664,000	1,536,000	1,498,000
5	5.250	15 3/4	33 3/4	36 1/4	46.2	1,874,000	1,828,000	1,686,000	1,644,000

TABLE XXII. Type I, general purpose, class 5, 6 by 61, extra improved plow steel, IWRC.

Rope diameter		Approximate circumference (inches)	Maximum strand pitch		Approximate weight (lb./ft.)	Uncoated		Galvanized	
Nominal (ordered) (minimum) (inches)	Maximum (inches)		Uncoated regular lay (inches)	Uncoated lang lay or galvanized regular lay (inches)		Nominal strength (lb.)	Acceptance breaking strength (lb.)	Nominal strength (lb.)	Acceptance breaking strength (lb.)
2	2.100	6 1/4	13 1/2	14 1/2	7.39	380,000	370,000	342,000	334,000
2 1/8	2.231	6 5/8	14 11/32	15 13/32	8.35	428,000	418,000	386,000	376,000
2 1/4	2.363	7 1/8	15 3/16	16 5/16	9.36	478,000	466,000	430,000	420,000
2 1/2	2.625	7 7/8	16 7/8	18 1/8	11.6	584,000	570,000	526,000	512,000
2 3/4	2.888	8 5/8	18 9/16	19 15/16	14.0	700,000	682,000	630,000	614,000
3	3.150	9 3/8	20 1/4	21 3/4	16.6	828,000	808,000	746,000	728,000
3 1/4	3.413	10 1/4	21 15/16	23 9/16	19.5	966,000	942,000	870,000	848,000
3 1/2	3.675	11	23 5/8	25 3/8	22.7	1,110,000	1,082,000	999,000	974,000
3 3/4	3.938	11 3/4	25 5/16	27 3/16	26.0	1,264,000	1,232,000	1,138,000	1,110,000
4	4.200	12 1/2	27	29	29.6	1,426,000	1,390,000	1,283,000	1,251,000
4 1/4	4.463	13 3/8	28 11/16	30 13/16	33.3	1,598,000	1,558,000	1,438,000	1,402,000
4 1/2	4.725	14 1/8	30 3/8	32 5/8	37.4	1,776,000	1,732,000	1,598,000	1,558,000
4 3/4	4.988	15	32 1/16	34 7/16	41.7	1,962,000	1,913,000	1,766,000	1,722,000
5	5.250	15 3/4	33 3/4	36 1/4	46.2	2,156,000	2,102,000	1,940,000	1,892,000

TABLE XXIII. Type I, general purpose, class 6, 6 by 91, improved plow steel, fiber cores.

Rope diameter		Approximate circumference (inches)	Maximum strand pitch		Approximate weight (lb./ft.)	Uncoated		Galvanized	
Nominal (ordered) (minimum) (inches)	Maximum (inches)		Uncoated regular lay (inches)	Uncoated lang lay or galvanized regular lay (inches)		Nominal strength (lb.)	Acceptance breaking strength (lb.)	Nominal strength (lb.)	Acceptance breaking strength (lb.)
2 1/2	2.625	7 7/8	17 1/2	18 1/8	10.5	450,000	438,000	406,000	396,000
2 3/4	2.888	8 5/8	19 1/4	20	12.7	540,000	526,000	486,000	473,000
3	3.150	9 3/8	21	21 3/4	15.1	636,000	620,000	572,000	558,000
3 1/4	3.413	10 1/4	22 3/4	23 1/2	17.7	742,000	724,000	668,000	652,000
3 1/2	3.675	11	24 1/2	25 3/8	20.6	852,000	830,000	766,000	746,000
3 3/4	3.938	11 3/4	26 1/4	27 1/4	23.6	972,000	948,000	874,000	852,000
4	4.200	12 1/2	28	29	26.9	1,096,000	1,068,000	986,000	962,000
4 1/4	4.463	13 3/8	29 3/4	30 7/8	30.3	1,228,000	1,198,000	1,106,000	1,078,000
4 1/2	4.725	14 1/8	31 1/2	32 5/8	34.0	1,366,000	1,332,000	1,230,000	1,200,000
4 3/4	4.988	15	33 1/4	34 1/2	37.9	1,506,000	1,468,000	1,356,000	1,322,000
5	5.250	15 3/4	35	36 1/4	42.0	1,658,000	1,616,000	1,492,000	1,454,000
5 1/4	5.513	16 1/2	36 3/4	38 1/8	46.3	1,812,000	1,766,000	1,630,000	1,589,000
5 1/2	5.775	17 1/4	38 1/2	39 7/8	50.8	1,972,000	1,922,000	1,774,000	1,730,000
5 3/4	6.038	18 1/8	40 1/4	41 3/4	55.5	2,136,000	2,082,000	1,922,000	1,814,000
6	6.300	18 7/8	42	43 1/2	60.5	2,306,000	2,248,000	2,076,000	2,024,000

TABLE XXIV. Type I, general purpose, class 6, 6 by 91, improved plow steel, IWRC.

Rope diameter		Approximate circumference (inches)	Maximum strand pitch		Approximate weight (lb./ft.)	Uncoated		Galvanized	
Nominal (ordered) (minimum) (inches)	Maximum (inches)		Uncoated regular lay (inches)	Uncoated lang lay or galvanized regular lay (inches)		Nominal strength (lb.)	Acceptance breaking strength (lb.)	Nominal strength (lb.)	Acceptance breaking strength (lb.)
2 1/2	2.625	7 7/8	17 1/2	18 1/8	11.6	484,000	472,000	436,000	426,000
2 3/4	2.888	8 5/8	19 1/4	20	14.0	580,000	566,000	522,000	508,000
3	3.150	9 3/8	21	21 3/4	16.6	684,000	666,000	616,000	600,000
3 1/4	3.413	10 1/4	22 3/4	23 1/2	19.5	798,000	778,000	718,000	700,000
3 1/2	3.675	11	24 1/2	25 3/8	22.7	916,000	894,000	824,000	804,000
3 3/4	3.938	11 3/4	26 1/4	27 1/4	26.0	1,044,000	1,018,000	940,000	916,000
4	4.200	12 1/2	28	29	29.6	1,178,000	1,148,000	1,060,000	1,034,000
4 1/4	4.463	13 3/8	29 3/4	30 7/8	33.3	1,320,000	1,288,000	1,188,000	1,158,000
4 1/2	4.725	14 1/8	31 1/2	32 5/8	37.4	1,468,000	1,432,000	1,322,000	1,288,000
4 3/4	4.988	15	33 1/4	34 1/2	41.7	1,620,000	1,580,000	1,458,000	1,422,000
5	5.250	15 3/4	35	36 1/4	46.2	1,782,000	1,738,000	1,604,000	1,564,000
5 1/4	5.513	16 1/2	36 3/4	38 1/8	49.8	1,948,000	1,900,000	1,754,000	1,710,000
5 1/2	5.775	17 1/4	38 1/2	39 7/8	54.5	2,120,000	2,068,000	1,908,000	1,860,000
5 3/4	6.038	18 1/8	40 1/4	41 3/4	59.6	2,296,000	2,238,000	2,066,000	2,014,000
6	6.300	18 7/8	42	43 1/2	65.0	2,480,000	2,418,000	2,232,000	2,176,000

TABLE XXV. Type I, general purpose, class 6, 6 by 91, extra improved plow steel, IWRC.

Rope diameter		Approximate circumference (inches)	Maximum strand pitch		Approximate weight (lb./ft.)	Uncoated		Galvanized	
Nominal (ordered) (minimum) (inches)	Maximum (inches)		Uncoated regular lay (inches)	Uncoated lang lay or galvanized regular lay (inches)		Nominal strength (lb.)	Acceptance breaking strength (lb.)	Nominal strength (lb.)	Acceptance breaking strength (lb.)
2 1/2	2.625	7 7/8	17 1/2	18 1/8	11.6	554,000	540,000	498,000	486,000
2 3/4	2.888	8 5/8	19 1/4	20	14.0	666,000	650,000	600,000	585,000
3	3.150	9 3/8	21	21 3/4	16.6	786,000	766,000	708,000	690,000
3 1/4	3.413	10 1/4	22 3/4	23 1/2	19.5	916,000	894,000	824,000	804,000
3 1/2	3.675	11	24 1/2	25 3/8	22.7	1,054,000	1,028,000	948,000	924,000
3 3/4	3.938	11 3/4	26 1/4	27 1/4	26.0	1,200,000	1,170,000	1,080,000	1,053,000
4	4.200	12 1/2	28	29	29.6	1,354,000	1,320,000	1,218,000	1,188,000
4 1/4	4.463	13 3/8	29 3/4	30 7/8	33.3	1,518,000	1,480,000	1,366,000	1,332,000
4 1/2	4.725	14 1/8	31 1/2	32 5/8	37.4	1,688,000	1,646,000	1,520,000	1,482,000
4 3/4	4.988	15	33 1/4	34 1/2	41.7	1,864,000	1,818,000	1,678,000	1,636,000
5	5.250	15 3/4	35	36 1/4	46.2	2,048,000	1,996,000	1,844,000	1,798,000
5 1/4	5.513	16 1/2	36 3/4	38 1/8	49.8	2,240,000	2,184,000	2,016,000	1,966,000
5 1/2	5.775	17 1/4	38 1/2	39 7/8	54.5	2,438,000	2,378,000	2,194,000	2,140,000
5 3/4	6.038	18 1/8	40 1/4	41 3/4	59.6	2,640,000	2,574,000	2,376,000	2,317,000
6	6.300	18 7/8	42	43 1/2	65.0	2,852,000	2,780,000	2,566,000	2,502,000

TABLE XXVI. Type II, elevator, class 1, 6 by 19, or class 2, 8 by 19, traction steel, fiber cores.

Rope diameter		Approximate circumference (inches)	Maximum strand pitch (inches)	Approximate weight		Nominal and acceptance breaking strength (lb.)
Nominal (ordered) (inches)	Maximum (no load) (inches)			6 by 19 (lb./ft.)	8 by 19 (lb./ft.)	
1/4	17/64	3/4	1 11/16	0.10	0.09	3,600
5/16	21/64	1	2 1/8	0.16	0.14	5,600
3/8	13/32	1 1/8	2 17/32	0.23	0.20	8,200
7/16	15/32	1 3/8	2 31/32	0.31	0.28	11,000
1/2	17/32	1 5/8	3 3/8	0.40	0.36	14,500
9/16	19/32	1 3/4	3 13/16	0.51	0.46	18,500
5/8	21/32	2	4 7/32	0.63	0.57	23,000
11/16	23/32	2 1/8	4 5/8	0.76	0.69	27,000
3/4	25/32	2 3/8	5 1/16	0.90	0.82	32,000
13/16	27/32	2 1/2	5 1/2	1.06	0.96	37,000
7/8	29/32	2 3/4	5 29/32	1.23	1.11	42,000
15/16	31/32	3	6 5/16	1.41	1.27	48,000
1	1 1/32	3 1/8	6 3/4	1.60	1.45	54,000
1 1/16	1 3/32	3 3/8	7 3/16	1.81	1.64	61,000

TABLE XXVII. Type II, elevator, class 1, 6 by 19, or class 2, 8 by 19, high-rise, fiber cores.

Rope diameter		Approximate circumference (inches)	Maximum strand pitch (inches)	Approximate weight		Nominal and acceptance breaking strength
Nominal (ordered) (inches)	Maximum (no load) (inches)			6 by 19 (lb./ft.)	8 by 19 (lb./ft.)	
11/16	23/32	2 1/8	4 5/8	0.76	0.69	30,000
13/16	27/32	2 1/2	5 1/2	1.06	0.96	46,000
15/16	31/32	3	6 5/16	1.41	1.27	60,000

TABLE XXVIII. Type II, elevator, class 1, 6 by 19, or class 2, 8 by 19, iron, fiber cores.

Rope diameter		Approximate circumference (inches)	Maximum strand pitch (inches)	Approximate weight		Nominal and acceptance breaking strength	
Nominal (ordered) (minimum) (inches)	Maximum (no load) (inches)			6 by 19 (lb./ft.)	8 by 19 (lb./ft.)	6 by 19 (lb./ft.)	8 by 19 (lb./ft.)
3/16	13/64			9/16	1 9/32	0.06	0.05
1/4	17/64	3/4	1 11/16	0.10	0.09	2,200	1,800
5/16	21/64	1	2 1/8	0.16	0.14	3,200	2,900
3/8	13/32	1 1/8	2 17/32	0.23	0.20	5,000	4,200
7/16	15/32	1 3/8	2 31/32	0.31	0.28	6,400	5,600
1/2	17/32	1 5/8	3 3/8	0.40	0.36	8,400	7,200
9/16	19/32	1 3/4	3 13/16	0.51	0.46	10,600	9,200
5/8	21/32	2	4 7/32	0.63	0.57	12,800	11,200
3/4	25/32	2 3/8	5 1/16	0.90	0.82	18,200	16,000
7/8	29/32	2 3/4	5 29/32	1.23	1.11	24,800	21,400
1	1 1/32	3 1/8	6 3/4	1.60	1.45	32,000	28,000

TABLE XXIX. Type III, marine (cables), class 1, 6 by 6, deck lashing ropes, improved plow steel, fiber core.

Rope diameter		Approximate circumference (inches)	Maximum strand pitch		Approximate weight (lb./ft.)	Uncoated		Galvanized	
Nominal (ordered) (minimum) (inch)	Maximum (inches)		Uncoated (inches)	Galvanized (inches)		Nominal strength (lb.)	Acceptance breaking strength (lb.)	Nominal strength (lb.)	Acceptance breaking strength (lb.)
3/8	0.394	1 1/8	2 17/32	2 23/32	0.18	9,960	9,720	8,960	8,740
7/16	0.459	1 3/8	2 31/32	3 3/16	0.25	13,480	13,140	12,140	11,840
1/2	0.525	1 5/8	3 3/8	3 5/8	0.33	17,520	17,080	15,760	15,360
9/16	0.591	1 3/4	3 13/16	4 1/16	0.42	22,000	21,400	19,800	19,300
5/8	0.656	2	4 7/32	4 17/32	0.51	27,000	26,400	24,400	23,800
3/4	0.788	2 3/8	5 1/16	5 7/16	0.73	38,600	37,600	34,800	34,000
7/8	0.919	2 3/4	5 29/32	6 11/32	1.00	52,200	50,800	47,000	45,800
1	1.050	3 1/8	6 3/4	7 1/4	1.30	67,600	66,000	60,800	59,200

TABLE XXX. Type III, marine (cables), class 2, 6 by 12, running ropes, improved plow steel, fiber cores, galvanized.

Rope diameter		Approximate circumference (inches)	Maximum strand pitch (inches)	Approximate weight (lb./ft.)	Nominal strength (lb.)	Acceptance breaking strength (lb.)
Nominal (ordered) (maximum) (inches)	Maximum (inches)					
1/4	0.265	3/4	1 13/16	0.07	3,020	2,940
5/16	0.328	1	2 9/32	0.10	4,680	4,560
3/8	0.394	1 1/8	2 23/32	0.15	6,720	6,560
7/16	0.459	1 3/8	3 3/16	0.20	9,100	8,880
1/2	0.525	1 5/8	3 5/8	0.26	11,820	11,520
9/16	0.591	1 3/4	4 1/16	0.33	14,900	14,520
5/8	0.656	2	4 17/32	0.41	18,320	17,860
3/4	0.788	2 3/8	5 7/16	0.59	26,200	25,600
13/16	0.853	2 1/2	5 29/32	0.69	30,600	29,800
7/8	0.919	2 3/4	6 11/32	0.80	35,400	34,600
1	1.050	3 1/8	7 1/4	1.05	46,000	44,800
1 1/16	1.116	3 3/8	7 11/16	1.19	51,800	50,600
1 1/8	1.181	3 1/2	8 5/32	1.33	58,000	56,600
1 3/16	1.247	3 3/4	8 19/32	1.48	64,400	62,800
1 1/4	1.313	3 7/8	9 1/16	1.64	71,200	69,400
1 3/8	1.444	4 3/8	9 31/32	1.99	85,600	83,400
1 7/16	1.509	4 1/2	10 13/32	2.17	93,400	91,000
1 1/2	1.575	4 3/4	10 7/8	2.36	101,400	98,800
1 5/8	1.706	5 1/8	11 25/32	2.77	118,400	115,400
1 11/16	1.772	5 1/4	12 1/4	2.99	127,200	124,000
1 3/4	1.838	5 1/2	12 11/16	3.22	136,600	133,200
1 13/16	1.903	5 3/4	13 1/8	3.45	146,000	142,400
1 15/16	2.034	6 1/8	14 1/16	3.94	166,000	161,800
2	2.100	6 1/4	14 1/2	4.20	176,400	172,000
2 1/16	2.166	6 1/2	14 15/16	4.47	187,200	182,600

TABLE XXXI. Type III, marine (cables), class 2, 6 by 12, running ropes, phosphor bronze, fiber cores.

Rope diameter		Approximate circumference (inches)	Maximum strand pitch (inches)	Approximate weight (lb./ft.)	Nominal breaking strength (lb.)	Acceptance breaking strength (lb.)
Nominal (ordered) (maximum) (inch)	Maximum (inch)					
1/4	0.265	3/4	1 13/16	0.075	1,470	1,440
5/16	0.328	1	2 9/32	0.115	2,260	2,200
3/8	0.394	1 1/8	2 23/32	0.168	3,220	3,140
7/16	0.459	1 3/8	3 3/16	0.227	4,380	4,280
1/2	0.525	1 5/8	3 5/8	0.295	5,640	5,500
9/16	0.591	1 3/4	4 1/16	0.370	7,100	6,920
5/8	0.656	2	4 17/32	0.460	8,740	8,520
3/4	0.788	2 3/8	5 7/16	0.660	12,240	11,940
13/16	0.853	2 1/2	5 29/32	0.766	14,300	13,940
7/8	0.919	2 3/4	6 11/32	0.895	16,600	16,180

TABLE XXXII. Type III, marine (cables), class 3, 6 by 24, mooring lines, improved plow steel, fiber cores, (galvanized).

Rope diameter		Approximate circumference (inches)	Maximum strand pitch (inches)	Approximate weight (lb./ft.)	Nominal breaking strength (lb.)	Acceptance breaking strength (lb.)
Nominal (ordered) (maximum) (inches)	Maximum (inches)					
3/8	0.394	1 1/8	2 23/32	0.194	9,540	9,300
1/2	0.525	1 5/8	3 5/8	0.35	16,800	16,380
5/8	0.656	2	4 17/32	0.54	26,000	25,400
3/4	0.788	2 3/8	5 7/16	0.78	37,200	36,200
13/16	0.853	2 1/2	5 7/8	0.91	43,600	42,600
7/8	0.919	2 3/4	6 11/32	1.06	50,400	49,200
1	1.050	3 1/8	7 1/4	1.38	65,600	64,000
1 1/16	1.116	3 3/8	7 11/16	1.56	73,800	72,000
1 1/8	1.181	3 1/2	8 5/32	1.75	82,400	80,400
1 3/16	1.247	3 3/4	9 19/32	1.95	91,800	89,600
1 1/4	1.313	3 7/8	9 1/16	2.16	101,400	98,800
1 3/8	1.444	4 3/8	9 31/32	2.61	122,000	119,000
1 7/16	1.509	4 1/2	10 13/32	2.85	133,000	129,600
1 1/2	1.575	4 3/4	10 7/8	3.11	144,600	141,000
1 5/8	1.706	5 1/8	11 25/32	3.64	169,000	164,800
1 11/16	1.772	5 1/4	12 1/4	3.93	181,800	177,200
1 3/4	1.838	5 1/2	12 11/16	4.23	195,000	190,000
1 13/16	1.903	5 3/4	13 5/32	4.53	208,000	202,000
1 15/16	2.034	6 1/8	14 1/16	5.18	238,000	232,000
2	2.100	6 1/4	14 1/2	5.52	252,000	246,000
2 1/16	2.166	6 1/2	14 15/16	5.87	268,000	262,000

TABLE XXXIII. Type III, marine (cables), class 4, 6 by 3 by 7, spring lay,
and class 5, 6 by 3 by 19, galvanized.

Rope diameter		Approximate circumference (inches)	Maximum strand pitch (inches)	Approximate weight (lb./ft.)	Nominal breaking strength (lb.)	Acceptance breaking strength (lb.)
Nominal (ordered) (maximum) (inches)	Maximum (inches)					
Class 4 - 6 by 3 by 7						
1/2	0.525	1 5/8	3 5/8	0.22	8,940	8,720
9/16	0.591	1 3/4	4 1/16	0.28	11,280	11,000
5/8	0.656	2	4 17/32	0.34	13,900	13,560
3/4	0.788	2 3/8	5 7/16	0.49	19,920	19,420
Class 5 - 6 by 3 by 19						
7/8	0.919	2 3/4	6 11/32	0.63	27,000	26,400
1	1.050	3 1/8	7 1/4	0.88	35,000	34,200
1 1/8	1.181	3 1/2	8 5/32	1.14	44,200	43,000
1 1/4	1.313	3 7/8	9 1/16	1.36	54,400	53,000
1 3/8	1.444	4 3/8	9 31/32	1.66	65,600	64,000
1 1/2	1.575	4 3/4	10 7/8	1.97	77,800	75,800
1 5/8	1.706	5 1/8	11 25/32	2.28	91,200	89,000
1 3/4	1.838	5 1/2	12 11/16	2.67	105,400	102,800
1 7/8	1.969	5 7/8	13 19/32	3.09	120,600	117,600
2	2.100	6 1/4	14 1/2	3.53	137,000	133,600
2 1/4	2.363	7 1/8	16 5/16	4.56	172,600	168,200
2 1/2	2.625	7 7/8	18 1/8	5.44	212,000	206,000

TABLE XXXIV. Type III, marine (cables), class 6, 6 by 42, tiller or hand control, improved plow steel.

Rope diameter		Approximate circumference (inches)	Maximum strand pitch		Approximate weight (lb./ft.)	Uncoated		Galvanized	
Nominal (ordered) (minimum) (inch)	Maximum (inch)		Uncoated (inches)	Galvanized (inches)		Nominal strength (lb.)	Acceptance breaking strength (lb.)	Nominal strength (lb.)	Acceptance breaking strength (lb.)
3/16	0.201	5/8	1 9/32	1 13/32	0.039	1,710	1,660	1,540	1,500
1/4	0.265	3/4	1 11/16	1 13/16	0.07	3,020	2,940	2,720	2,650
5/16	0.328	1	2 1/8	2 8/32	0.11	4,700	4,580	4,230	4,120
3/8	0.394	1 1/8	2 17/32	2 23/32	0.16	6,740	6,580	6,060	5,900
7/16	0.459	1 3/8	2 31/32	3 3/16	0.21	9,160	8,940	8,240	8,040
1/2	0.525	1 5/8	3 3/8	3 5/8	0.28	11,920	11,620	10,720	10,460
9/16	0.591	1 3/4	3 13/16	4 3/32	0.35	15,020	14,640	13,520	13,180
5/8	0.656	2	4 7/32	4 17/32	0.43	18,500	18,040	16,600	16,240

TABLE XXXV. Type III, marine (cables), class 6, 6 by 42 tiller or hand control, phosphor bronze, fiber cores.

Rope diameter		Approximate circumference (inches)	Maximum strand pitch (inches)	Approximate weight (lb./ft.)	Nominal breaking strength (lb.)	Acceptance breaking strength (lb.)
Nominal (ordered) (maximum) (inch)	Maximum (inch)					
3/16	0.201	5/8	1 9/32	0.04	760	740
1/4	0.265	3/4	1 11/16	0.08	1,350	1,320
5/16	0.328	1	2 3/32	0.12	2,070	2,020
3/8	0.394	1 1/8	2 17/32	0.17	2,960	2,880
7/16	0.459	1 3/8	2 31/32	0.24	4,020	3,920
1/2	0.525	1 5/8	3 3/8	0.31	5,190	5,060
9/16	0.591	1 3/4	3 13/16	0.39	6,500	6,340
5/8	0.656	2	4 7/32	0.48	8,000	7,800
3/4	0.788	2 3/8	5 1/16	0.69	11,400	11,120

TABLE XXXVI. Type IV, miscellaneous, class 1, 5 by 19 marline-clad, improved plow steel, fiber cores.

Nominal diameter			Approximate circumference (inches)	Maximum strand pitch (inches)	Approximate weight (lb./ft.)	Nominal breaking strength (lb.)	Acceptance breaking strength (lb.)
Before serving (inches)	After serving (minimum) (inches)	Maximum diameter after serving (inches)					
1/4	9/16	5/8	1 3/4	3 25/32	0.21	4,980	4,860
5/16	5/8	11/16	2	4 7/32	0.28	7,740	7,540
3/8	11/16	3/4	2 1/8	4 5/8	0.36	11,100	10,820
7/16	3/4	13/16	2 3/8	5 1/16	0.42	15,020	14,640
1/2	13/16	7/8	2 1/2	5 15/32	0.51	19,540	19,040
9/16	7/8	15/16	2 3/4	5 29/32	0.62	24,600	24,000
5/8	1	1 1/16	3 1/8	6 3/4	0.81	30,200	29,400
3/4	1 1/8	1 3/16	3 1/2	7 19/32	1.10	43,200	42,200
7/8	1 1/4	1 5/16	3 7/8	8 7/16	1.32	58,600	57,200
1	1 3/8	1 7/16	4 3/8	9 9/32	1.70	76,000	74,100
1 1/8	1 1/2	1 9/16	4 3/4	10 1/8	2.12	95,600	93,200
1 1/4	1 5/8	1 11/16	5 1/8	10 31/32	2.58	117,400	114,400
1 3/8	1 3/4	1 13/16	5 1/2	11 13/16	3.14	141,200	137,600

TABLE XXXVII. Type IV, miscellaneous, class 2, 18 by 7, rotation resistant, improved plow steel, fiber core or wire stand core.

Rope diameter		Approximate circumference (inches)	Maximum strand pitch		Approximate weight		Uncoated		Galvanized	
Nominal (ordered) (minimum) (inches)	Maximum (inches)		Inner strand layer (inches)	Outer strand layer (inches)	Fiber core (lb./ft.)	Wire strand core (lb./ft.)	Nominal strength (lb.)	Acceptance breaking strength (lb.)	Nominal strength (lb.)	Acceptance breaking strength (lb.)
3/8	0.394	1 1/8	1 11/16	2 23/32	0.24	0.25	11,180	10,900	10,060	9,800
7/16	0.459	1 3/8	1 31/32	3 3/16	0.33	0.35	15,160	14,780	13,640	13,300
1/2	0.525	1 5/8	2 1/4	3 5/8	0.43	0.45	19,700	19,200	17,740	17,300
9/16	0.591	1 3/4	2 17/32	4 3/32	0.55	0.58	24,800	24,200	22,400	21,800
5/8	0.656	2	2 13/16	4 17/32	0.68	0.71	30,600	29,800	27,600	27,000
3/4	0.788	2 3/8	3 3/8	5 7/16	0.97	1.02	43,600	42,600	39,200	38,200
7/8	0.919	2 3/4	3 15/16	6 11/32	1.32	1.39	59,000	57,600	53,100	51,800
1	1.050	3 1/8	4 1/2	7 1/4	1.73	1.82	76,600	74,600	69,000	67,200
1 1/8	1.181	3 1/2	5 1/16	8 5/32	2.19	2.30	96,400	94,000	86,800	84,600
1 1/4	1.313	3 7/8	5 9/16	9 1/16	2.70	2.84	118,400	115,400	106,600	104,000
1 3/8	1.444	4 3/8	6 3/16	9 31/32	3.27	3.43	142,600	139,000	128,400	125,200
1 1/2	1.575	4 3/4	6 3/4	10 7/8	3.89	4.08	168,800	164,600	152,000	148,200
1 5/8	1.706	5 1/8	7 5/16	11 25/32	4.57	4.80	196,800	191,800	177,200	172,800
1 3/4	1.838	5 1/2	7 7/8	12 11/16	5.30	5.57	228,000	222,000	206,000	200,000

TABLE XXXVIII. Type IV, miscellaneous, class 2, 18 by 7, rotation resistant, extra improved plow steel, fiber core or wire stand core.

Rope diameter		Approximate circumference (inches)	Maximum strand pitch		Approximate weight		Uncoated		Galvanized	
Nominal (ordered) (minimum) (inches)	Maximum (inches)		Inner strand layer (inches)	Outer strand layer (inches)	Fiber core (lb./ft.)	Wire strand core (lb./ft.)	Nominal strength (lb.)	Acceptance breaking strength (lb.)	Nominal strength (lb.)	Acceptance breaking strength (lb.)
3/8	0.394	1 1/8	1 11/16	2 23/32	0.24	0.25	12,300	12,000	11,080	10,800
7/16	0.459	1 3/8	1 31/32	3 3/16	0.33	0.35	16,660	16,240	15,000	14,620
1/2	0.525	1 5/8	2 1/4	3 5/8	0.43	0.45	21,600	21,000	19,440	18,960
9/16	0.591	1 3/4	2 17/32	4 3/32	0.55	0.58	27,200	26,600	24,400	23,800
5/8	0.656	2	2 13/16	4 17/32	0.68	0.71	33,600	32,800	30,200	29,400
3/4	0.788	2 3/8	3 3/8	5 7/16	0.97	1.02	48,000	46,800	43,200	42,200
7/8	0.919	2 3/4	3 15/16	6 11/32	1.32	1.39	65,000	63,400	58,500	57,200
1	1.050	3 1/8	4 1/2	7 1/4	1.73	1.82	84,400	82,200	76,000	74,000
1 1/8	1.181	3 1/2	5 1/16	8 5/32	2.19	2.30	106,200	103,600	95,600	93,200
1 1/4	1.313	3 7/8	5 9/16	9 1/16	2.70	2.84	130,200	127,000	117,200	114,200
1 3/8	1.444	4 3/8	6 3/16	9 31/32	3.27	3.43	156,800	152,800	141,200	137,600
1 1/2	1.575	4 3/4	6 3/4	10 7/8	3.89	4.08	185,600	181,000	167,000	162,800
1 5/8	1.706	5 1/8	7 5/16	11 25/32	4.57	4.80	216,000	210,000	194,400	189,600
1 3/4	1.838	5 1/2	7 7/8	12 11/16	5.30	5.57	250,000	244,000	225,000	220,000

TABLE XXXIX. Type IV, miscellaneous, class 3, flattened strand, construction 1, 6 by 25, style B; construction 2, 6 by 30, style G; construction 3, 6 by 27, style H; construction 4, 6 by 31, style V; improved plow steel, fiber cores.

Rope diameter		Approximate circumference (inches)	Approximate strand pitch (inches)	Approximate weight (lb./ft.)	Uncoated		Galvanized	
Nominal (ordered) (minimum) (inches)	Maximum (inches)				Nominal strength (lb.)	Acceptance breaking strength (lb.)	Nominal strength (lb.)	Acceptance breaking strength (lb.)
3/8 ¹	0.394	1 1/8	3	0.25	13,420	13,080	12,080	11,780
1/2 ¹	0.525	1 5/8	4	0.45	23,600	23,000	21,200	20,600
9/16 ¹	0.591	1 3/4	4 1/2	0.57	29,800	29,000	26,800	26,200
5/8	0.656	2	5	0.70	36,600	35,600	33,000	32,200
3/4	0.788	2 3/8	6	1.01	52,400	51,000	47,200	46,000
7/8	0.919	2 3/4	7	1.39	70,800	69,000	63,800	62,200
1	1.050	3 1/8	8	1.80	92,000	89,700	82,800	80,700
1 1/8	1.181	3 1/2	9	2.28	115,800	113,000	104,200	101,600
1 1/4	1.313	3 7/8	10	2.81	142,000	138,400	127,800	124,600
1 3/8	1.444	4 3/8	11	3.40	171,000	166,800	154,000	150,200
1 1/2	1.575	4 3/4	12	4.05	202,000	197,000	181,800	177,200
1 5/8	1.706	5 1/8	13	4.75	236,000	230,000	212,000	206,000
1 3/4	1.838	5 1/2	14	5.51	272,000	266,000	244,000	238,000
2	2.100	6 1/4	16	7.20	352,000	344,000	316,000	308,000
2 1/4	2.363	7 1/8	18	9.10	440,000	430,000	396,000	386,000
2 1/2	2.625	7 7/8	20	11.20	538,000	524,000	484,000	472,000
2 3/4	2.888	8 5/8	22	13.60	642,000	626,000	578,000	564,000

¹Applies to construction 1, style B only.

TABLE XL. Type IV, miscellaneous, class 3, flattened strand, construction 1, 6 by 25, style B; construction 2, 6 by 30, style G; construction 3, 6 by 27, style H; construction 4, 6 by 31, style V; improved plow steel, wire strand core or IWRC.

Rope diameter		Approximate circumference (inches)	Approximate strand pitch (inches)	Approximate weight (lb./ft.)	Uncoated		Galvanized	
Nominal (ordered) (minimum) (inches)	Maximum (inches)				Nominal strength (lb.)	Acceptance breaking strength (lb.)	Nominal strength (lb.)	Acceptance breaking strength (lb.)
3/8 ¹	0.394	1 1/8	3	0.26	14,420	14,060	12,980	12,660
1/2 ¹	0.525	1 5/8	4	0.47	25,400	24,800	22,800	22,200
9/16 ¹	0.591	1 3/4	4 1/2	0.60	32,000	31,200	28,800	28,000
5/8	0.656	2	5	0.74	39,400	38,400	35,400	34,600
3/4	0.788	2 3/8	6	1.06	56,400	55,000	50,800	49,600
7/8	0.919	2 3/4	7	1.46	76,000	74,100	68,400	66,700
1	1.050	3 1/8	8	1.89	98,800	96,400	89,000	86,800
1 1/8	1.181	3 1/2	9	2.39	124,400	121,200	112,000	109,200
1 1/4	1.313	3 7/8	10	2.95	152,600	148,800	137,400	134,000
1 3/8	1.444	4 3/8	11	3.57	183,800	179,200	165,400	161,200
1 1/2	1.575	4 3/4	12	4.25	216,000	210,000	194,400	189,600
1 5/8	1.706	5 1/8	13	4.99	254,000	248,000	228,600	222,000
1 3/4	1.838	5 1/2	14	5.79	292,000	284,000	262,000	256,000
2	2.100	6 1/4	16	7.56	378,000	368,000	340,000	332,000
2 1/4	2.363	7 1/8	18	9.56	472,000	460,000	424,000	414,000
2 1/2	2.625	7 7/8	20	11.8	578,000	564,000	520,000	508,000
2 3/4	2.888	8 5/8	22	14.3	690,000	672,000	621,000	606,000

¹Applies to construction 1, style B only.

TABLE XLI. Type IV, miscellaneous, class 3, flattened strand, construction 1, 6 by 25, style B;
construction 2, 6 by 30, style G; construction 3, 6 by 27, style H; construction 4,
6 by 31, style V; extra improved plow steel, wire strand core or IWRC.

Rope diameter		Approximate circumference (inches)	Approximate strand pitch (inches)	Approximate weight (lb./ft.)	Uncoated		Galvanized	
Nominal (ordered) (minimum) (inches)	Maximum (inches)				Nominal strength (lb.)	Acceptance breaking strength (lb.)	Nominal strength (lb.)	Acceptance breaking strength (lb.)
3/8 ¹	0.394	1 1/8	3	0.26	15,880	15,480	14,300	13,940
1/2 ¹	0.525	1 5/8	4	0.47	28,000	27,300	25,200	24,600
9/16 ¹	0.591	1 3/4	4 1/2	0.60	35,200	34,400	31,600	30,800
5/8	0.656	2	5	0.74	43,400	42,400	39,000	38,000
3/4	0.788	2 3/8	6	1.06	62,000	60,400	55,800	54,400
7/8	0.919	2 3/4	7	1.46	83,800	81,800	75,400	73,600
1	1.050	3 1/8	8	1.89	108,800	106,000	98,000	95,600
1 1/8	1.181	3 1/2	9	2.39	137,000	133,600	123,300	120,200
1 1/4	1.313	3 7/8	10	2.95	168,000	163,800	151,200	147,400
1 3/8	1.444	4 3/8	11	3.57	202,000	197,000	181,800	177,200
1 1/2	1.575	4 3/4	12	4.25	238,000	232,000	214,000	208,000
1 5/8	1.706	5 1/8	13	4.99	280,000	273,000	252,000	246,000
1 3/4	1.838	5 1/2	14	5.79	322,000	314,000	290,000	282,000
2	2.100	6 1/4	16	7.56	414,000	404,000	372,000	362,000
2 1/4	2.363	7 1/8	18	9.56	520,000	507,000	468,000	456,000
2 1/2	2.625	7 7/8	20	11.8	636,000	620,000	572,000	558,000
2 3/4	2.888	8 5/8	22	14.3	762,000	742,000	686,000	668,000

¹Applies to construction 1, style B only.

TABLE XLII. Type IV, miscellaneous, class 4, 8 by 19, rotation resistant, improved plow steel, IWRC.

Rope diameter		Approximate circumference (inches)	Maximum strand pitch (inches)	Approximate weight (lb./ft.)	Uncoated		Galvanized	
Nominal (inches)	Maximum (inches)				Nominal strength (lb.)	Acceptance breaking strength (lb.)	Nominal strength (lb.)	Acceptance breaking strength (lb.)
1/4	0.265	3/4	1 11/16	0.12	5,160	5,040	4,640	4,520
5/16	0.328	1	2 1/8	0.18	8,020	7,820	7,220	7,040
3/8	0.394	1 1/8	2 17/32	0.26	11,520	11,240	10,360	10,100
7/16	0.459	1 3/8	2 31/32	0.36	15,600	15,220	14,040	13,680
1/2	0.525	1 5/8	3 3/8	0.47	20,200	19,700	18,180	17,720
9/16	0.591	1 3/4	3 13/16	0.60	25,600	25,000	23,000	22,400
5/8	0.656	2	4 7/32	0.73	31,400	30,600	28,200	27,400
3/4	0.788	2 3/8	5 1/16	1.06	45,000	43,800	40,600	39,600
7/8	0.919	2 3/4	5 29/32	1.44	61,000	59,400	55,000	53,600
1	1.050	3 1/8	6 3/4	1.88	79,200	77,200	71,200	69,400
1 1/8	1.181	3 1/2	7 19/32	2.39	99,600	97,200	89,600	87,400
1 1/4	1.313	3 7/8	8 7/16	2.94	122,600	119,600	110,400	107,600
1 3/8	1.444	4 3/8	9 9/32	3.56	147,600	144,000	132,800	129,400
1 1/2	1.575	4 3/4	10 1/8	4.24	174,600	170,200	157,200	153,200

TABLE XLIII. Type IV, miscellaneous, class 4, 8 by 19, rotation resistant, extra improved plow steel, IWRC.

Rope diameter		Approximate circumference (inches)	Maximum strand pitch (inches)	Approximate weight (lb./ft.)	Uncoated		Galvanized	
Nominal (inches)	Maximum (inches)				Nominal strength (lb.)	Acceptance breaking strength (lb.)	Nominal strength (lb.)	Acceptance breaking strength (lb.)
1/4	0.265	3/4	1 11/16	0.12	5,940	5,800	5,340	5,200
5/16	0.328	1	2 1/8	0.18	9,240	9,000	8,320	8,120
3/8	0.394	1 1/8	2 17/32	0.26	13,260	12,920	11,940	11,640
7/16	0.459	1 3/8	2 31/32	0.36	17,940	17,500	16,140	15,740
1/2	0.525	1 5/8	3 3/8	0.47	23,200	22,600	20,900	20,300
9/16	0.591	1 3/4	3 13/16	0.60	29,400	28,600	26,400	25,800
5/8	0.656	2	4 7/32	0.73	36,200	35,200	32,600	31,800
3/4	0.788	2 3/8	5 1/16	1.06	51,800	50,600	46,600	45,400
7/8	0.919	2 3/4	5 29/32	1.44	70,000	68,200	63,000	61,400
1	1.050	3 1/8	6 3/4	1.88	91,000	88,800	82,000	80,000
1 1/8	1.181	3 1/2	7 19/32	2.39	114,600	111,800	103,200	100,600
1 1/4	1.313	3 7/8	8 7/16	2.94	141,000	137,400	127,000	123,800
1 3/8	1.444	4 3/8	9 9/32	3.56	169,800	165,600	152,800	149,000
1 1/2	1.575	4 3/4	10 1/8	4.24	200,000	195,000	180,000	175,600

TABLE XLIV. Type V, auxiliary wire strands, class 1, 1 by 7, seizing strand, iron, annealed steel, or corrosion-resistant steel.

Strand diameter		Approximate diameter of wires (inch)	Maximum pitch (inches)	Approximate length of strand on reel (ft.)	Approximate weight		Nominal and acceptance breaking strength (lb.)
Nominal (ordered) (minimum) (inch)	Maximum (inch)				Per foot (lb.)	Per reel (lb.)	
1/16	5/64	0.022	3/4	5,000	0.010	50	140
3/32	7/64	0.032	1 1/8	2,500	0.020	50	300
1/8	9/64	0.042	1 1/2	1,500	0.033	50	530
5/32	11/64	0.052	1 7/8	1,000	0.050	50	810

TABLE XLV. Type V, auxiliary wire strands, class 2, 1 by 19, seizing strand (2 operations), iron or annealed steel.

Strand diameter		Approximate diameter of wires (inch)	Maximum pitch (inches)	Approximate length of strand on reel (ft.)	Approximate weight		Nominal and acceptance breaking strength (lb.)
Nominal (ordered) (minimum) (inch)	Maximum (inch)				Per foot (lb.)	Per reel (lb.)	
3/16	13/64	0.039	2 1/4	1,200	0.080	100	1,100
1/4	17/64	0.052	3	750	0.133	100	1,900

TABLE XLVI. Type VI, small cords, class 1, class 2, and class 3, high quality carbon steel, drawn galvanized, and corrosion-resistant steel, wire strand core (class 2 and 3 only)¹.

Rope diameter		Class	Construction	Approximate circumference (inches)	Allowable increase at cut end (inch)	Strand pitch		Approx. weight (lb./100 ft.)	Nominal and acceptance breaking strength	
Nominal (ordered) (minimum) (inch)	Maximum (inch)					Min. (inches)	Max. (inches)		Drawn galvanized high carbon steel (lb.)	Corrosion resistant steel (lb.)
1/32	0.037	1	3 by 7	3/32	0.006	5/32	7/32	0.16	110	110
3/64	0.055	1	3 by 7	9/64	0.008	15/64	21/64	0.33	230	230
3/64	0.055	2	7 by 7	9/64	0.008	9/32	3/8	0.42	270	270
1/16	0.073	2	7 by 7	13/64	0.009	3/8	1/2	0.75	480	480
3/32	0.106	2	7 by 7	19/64	0.010	9/16	3/4	1.60	920	920
1/16	0.073	3	7 by 19	13/64	0.009	3/8	1/2	0.75	480	480
3/32	0.106	3	7 by 19	19/64	0.010	9/16	3/4	1.74	1,000	920
1/8	0.139	3	7 by 19	25/64	0.011	3/4	1	2.90	2,000	1,760
5/32	0.172	3	7 by 19	1/2	0.017	15/16	1 1/4	4.50	2,800	2,400
3/16	0.206	3	7 by 19	9/16	0.019	1 1/8	1 1/2	6.50	4,200	3,700
7/32	0.237	3	7 by 19	11/16	0.020	1 5/16	1 3/4	8.60	5,600	5,000
1/4	0.268	3	7 by 19	3/4	0.021	1 1/2	2	11.00	7,000	6,400
9/32	0.301	3	7 by 19	7/8	0.023	1 11/16	2 1/4	13.90	8,000	7,800
5/16	0.335	3	7 by 19	1	0.024	1 7/8	2 1/2	17.30	9,800	9,000
3/8	0.401	3	7 by 19	1 1/8	0.027	2 1/4	3	24.30	14,400	12,000

¹This type not intended for use in aircraft control system. For such wire rope, see MIL-DTL-83420.

TABLE XLVII. Minimum free length of wire rope and strand for tensile test.

Size range (inch)	Recommended length ¹ (ft. minimum)
1/64 - 1/4	2
5/16 - 3/4	4
7/8 and larger	6

¹These lengths represent clear rope between attachments.

TABLE XLVIII. Tensile force on wires during torsional test.

Wire diameter		Tensile force	
From - (inch)	To - (inch)	Minimum (lb.)	Maximum (lb.)
0.000	0.009	0.5	1
0.010	0.014	1.0	2
0.015	0.019	1.5	3
0.020	0.029	2.0	4
0.030	0.039	3.0	6
0.040	0.049	4.0	8
0.050	0.059	5.0	10
0.060	0.069	6.0	12
0.070	0.079	7.0	14
0.080	0.089	8.0	16
0.090	0.099	9.0	18
0.100	0.109	10.0	20
0.110	0.119	11.0	22
0.120	0.129	12.0	24
0.130	0.139	13.0	26
0.140	0.149	14.0	28
0.150	0.159	15.0	30
0.160	0.169	16.0	32
0.170	0.189	19.0	38
0.190	0.209	22.0	44
0.210	0.229	25.0	50
0.230	0.249	28.0	56

TABLE XLIX. Differences in diameter.

Diameter before seizing is removed (inches)	Increase in diameter after seizing removed (inch)
0 to 3/4	1/32
13/16 to 1 1/8	3/64
1 3/16 to 1 1/2	1/16
1 9/16 to 2 1/4	3/32
2 5/16 and larger	1/8

TABLE L. Wire rope and strand construction for constructions commercially available.

Construction	Center wires	Around center wires	Inside wires	Inside intermediate wires	Filler wires	Outside intermediate wires		Outside wires		Wires per strand	Total wires in rope	Sizes ¹	Type of lay	
						Small	Large	Small	Large					
-	1	-	-	Type I, general purpose, class 1, 6 by 7				-	-	6	7	42	All	Right regular
1-Two operation	1	-	6	Type I, general purpose, class 2, 6 by 19				-	-	12	19	114	3/8 inch and smaller	Right or left regular
2-Warrington	1	-	6	-	-	-	-	6	6	19	114	1/2 inch and smaller	Right or left regular	
3-Seale	1	-	9	-	-	-	-	-	9	19	114	All	Right or left regular or lang	
4-Filler wire	1	-	5	-	5	-	-	-	10	21	126	3/8 inch and larger	Right or left regular or lang	
4-Filler wire	1	-	6	-	6	-	-	-	12	25	150	3/8 inch and larger	Right or left regular or lang	
5-Warrington-Seale	1	-	5	-	-	5	5	-	10	26	156	1/2 inch and larger	Right or left regular or lang	

TABLE L. Wire rope and strand construction for constructions commercially available - Continued.

Construction	Center wires	Around center wires	Inside wires	Inside intermediate wires	Filler wires	Outside intermediate wires		Outside wires		Wires per strand	Total wires in rope	Sizes ¹	Type of lay
						Small	Large	Small	Large				
1-Three operation	1	-	6	12	-	-	-	-	18	37	222	3/8 inch and smaller	Right or left regular
2-Two operation	1	-	6	-	-	6	6	-	14	33	198	1/2 inch and smaller	Right or left regular
2-Two operation	1	-	6	-	-	6	6	-	18	37	222	1/2 inch and smaller	Right or left regular
6-Warrington-Seale	1	-	6	-	-	6	6	-	12	31	186	1/2 inch and larger	Right or left regular or lang
6-Warrington-Seale	1	-	7	-	-	7	7	-	14	36	216	1/2 inch and larger	Right or left regular or lang
6-Warrington-Seale	1	-	8	-	-	8	8	-	16	41	246	1/2 inch and larger	Right or left regular or lang
7-Seale-Filler wire	1	-	7	7	7	-	-	-	14	36	216	1/2 inch and larger	Right or left regular or lang

TABLE L. Wire rope and strand construction for constructions commercially available - Continued.

Construction	Center wires	Around center wires	Inside wires	Inside intermediate wires	Filler wires	Outside intermediate wires		Outside wires		Wires per strand	Total wires in rope	Sizes ¹	Type of lay
						Small	Large	Small	Large				
7-Seale-Filler wire	1	-	8	8	8	-	-	-	16	41	246	1/2 inch and larger	Right or left regular or lang
7-Seale-Filler wire	1	-	9	9	9	-	-	-	18	46	276	1/2 inch and larger	Right or left regular or lang
8-Filler wire-Seale	1	-	5	-	5	-	10	-	10	31	186	1/2 inch and larger	Right or left regular or lang
8-Filler wire-Seale	1	-	8	-	8	-	16	-	16	49	294	1/2 inch and larger	Right or left regular or lang
9-Seale-Warrington-Seale	1	-	8	8	-	8	8	-	16	49	294	2 inch and larger	Right or left regular or lang
Type I, general purpose, class 4, 8 by 19													
1-Two operation	1	-	6	-	-	-	-	-	12	19	152	1/4 inch only	Right regular
2-Warrington	1	-	6	-	-	-	-	6	6	19	152	All	Right regular

TABLE L. Wire rope and strand construction for constructions commercially available - Continued.

Construction	Center wires	Around center wires	Inside wires	Inside intermediate wires	Filler wires	Outside intermediate wires		Outside wires		Wires per strand	Total wires in rope	Sizes ¹	Type of lay
						Small	Large	Small	Large				
3-Seale	1	-	9	-	-	-	-	-	9	19	152	All	Right regular
4-Filler wire	1	-	5	-	5	-	-	-	10	21	168	7/16 inch and larger	Right regular
4-Filler wire	1	-	6	-	6	-	-	-	12	25	200	7/16 inch and larger	Right regular
5-Warrington-Seale	1	-	5	-	-	5	5	-	10	26	208	3/8 inch and larger	Right regular
Type I, general purpose, class 5, 6 by 61													
5-Seale-Warrington-Seale	1	9	-	9	-	9	9	-	18	55	330	2 inch and larger	Right or left regular or lang
5-Seale-Warrington-Seale	1	10	10	-	-	10	10	-	20	61	366	2 inch and larger	Right or left regular or lang
5-Seale-Warrington-Seale	1	12	12	-	-	12	12	-	24	73	438	2 inch and larger	Right or left regular or lang

TABLE L. Wire rope and strand construction for constructions commercially available - Continued.

Construction	Center wires	Around center wires	Inside wires	Inside intermediate wires	Filler wires	Outside intermediate wires		Outside wires		Wires per strand	Total wires in rope	Sizes ¹	Type of lay
						Small	Large	Small	Large				
6-Seale- Filler wire-Seale	1	9	-	9	9	-	18	-	18	64	384	2 inch and larger	Right or left regular or lang
Type II, elevator, class 1, 6 by 19													
1-Warrington	1	-	6	-	-	-	-	6	6	19	114	5/16 inch and smaller	Right regular
2-Filler wire	1	-	5	-	5	-	-	-	10	21	126	3/8 inch and larger	Right regular
2-Filler wire	1	-	6	-	6	-	-	-	12	25	150	3/8 inch and larger	Right regular
3-Warrington-Seale	1	-	5	-	-	5	5	-	10	26	156	3/8 inch and larger	Right regular
Type II, elevator, class 2, 8 by 19													
1-Two operation	1	-	6	-	-	-	-	-	12	19	152	1/4 inch only	Right regular
2-Warrington	1	-	6	-	-	-	-	6	6	19	152	1/4 inch thru 7/16 inch	Right regular

TABLE L. Wire rope and strand construction for constructions commercially available - Continued.

Construction	Center wires	Around center wires	Inside wires	Inside intermediate wires	Filler wires	Outside intermediate wires		Outside wires		Wires per strand	Total wires in rope	Sizes ¹	Type of lay
						Small	Large	Small	Large				
3-Seale	1	-	9	-	-	-	-	-	9	19	152	All	Right regular
4-Filler wire	1	-	5	-	5	-	-	-	10	21	168	7/16 inch and larger	Right regular
4-Filler wire	1	-	6	-	6	-	-	-	12	25	200	7/16 inch and larger	Right regular
5-Warrington-Seale	1	-	5	-	-	5	5	-	10	26	208	3/8 inch and larger	Right regular
Type III, tiller rope, class 6, 6 by 42 (6 by 6 by 7) ²													
-	1	-	-	-	-	-	-	-	6	7	252	All	Right regular
Type IV, marline clad, class 1, 5 by 19													
1-Two operation	1	-	6	-	-	-	-	-	12	19	95	All	Right regular
2-Warrington	1	-	6	-	-	-	-	6	6	19	95	All	Right regular
3-Filler wire	1	-	5	-	5	-	-	-	10	21	105	All	Right regular

TABLE L. Wire rope and strand construction for constructions commercially available - Continued.

Construction	Center wires	Around center wires	Inside wires	Inside intermediate wires	Filler wires	Outside intermediate wires		Outside wires		Wires per strand	Total wires in rope	Sizes ¹	Type of lay
						Small	Large	Small	Large				
3-Filler wire	1	-	6	-	6	-	-	-	12	25	125	All	Right regular
				Type IV, rotation resistant, class 2, 18 by 7 ³									
18 by 7	1	-	-	-	-	-	-	-	6	7	126	All	Right regular
				Type IV, flattened strand, class 3, 6 strand rope									
1-Style B	Δ	-	12	-	-	-	-	-	12	25	150	All	Right lang
2-Style G	6	-	12	-	-	-	-	-	12	30	180	All	Right lang
3-Style H	3	-	12	-	-	-	-	-	12	27	162	All	Right lang
4-Style V	1	6	12	-	-	-	-	-	12	31	186	All	Right lang
				Type IV, rotation resistant, class 4, 8 by 19									
1-Seale	1	-	9	-	-	-	-	-	9	19	152	All	Right regular
2-Filler wire	1	-	5	-	5	-	-	-	10	21	168	All	Right regular
2-Filler wire	1	-	6	-	6	-	-	-	12	25	200	All	Right regular

TABLE L. Wire rope and strand construction for constructions commercially available - Continued.

Construction	Center wires	Around center wires	Inside wires	Inside intermediate wires	Filler wires	Outside intermediate wires		Outside wires		Wires per strand	Total wires in rope	Sizes ¹	Type of lay
						Small	Large	Small	Large				
3-Warrington-Seale	1	-	5	-	-	5	5	-	10	26	208	All	Right regular
-	1	-	-	Type V, seizing strand, class 1, 1 by 7				-	6	7	7	All	Left
Two operation	1	-	6	Type V, seizing strand, class 2, 1 by 19				-	12	19	19	All	Left
-	1	-	-	Type VI, small cords, class 1, 3 by 7				-	6	7	21	1/32 and 3/64 inch	Right regular
-	1	-	-	Type VI, small cords, class 2, 7 by 7				-	6	7	49	3/64, 1/16, and 3/32 inch	Right regular

TABLE L. Wire rope and strand construction for constructions commercially available - Continued.

Construction	Center wires	Around center wires	Inside wires	Inside intermediate wires	Filler wires	Outside intermediate wires		Outside wires		Wires per strand	Total wires in rope	Sizes ¹	Type of lay
						Small	Large	Small	Large				
Two operation	1	-	6	Type VI, small cords, class 3, 7 by 19				-	12	19	133	1/16 inch thru 3/8 inch	Right regular

¹Sizes refer to those listed in the respective tables for each type and class of rope.

²Denotes commercial description (see 3.13.5.5).

³Denotes commercial description (see 3.14.3).

TABLE LI. Wire rope and strand construction for special applications.

Construction	Center wires	Around center wires	Inside wires		Inside intermediate wires	Filler wires	Outside intermediate wires		Outside wires		Wires per strand	Total wires in rope	Sizes ¹	Type of lay
			Small	Large			Small	Large	Small	Large				
1- Three operations	1	-	-	6	12	-	-	-	-	15	34	204	3/8 inch and smaller	Right or left regular
	1	-	-	6	12	-	-	-	-	16	35	210		
2- Two operations	1	-	-	6	-	-	6	6	-	16	35	210	1/2 inch and smaller	Right or left regular
	1	-	9	-	-	-	-	9	-	14	33	198		
	1	-	9	-	-	-	-	9	-	16	35	210		
	1	-	9	-	-	-	-	9	-	18	37	222		
	1	-	-	5	-	5	-	10	-	14	35	210		
	1	-	-	5	-	5	-	10	-	16	37	222		
	1	-	-	5	-	5	-	10	-	18	39	234		
	1	-	-	6	-	6	-	12	-	14	39	234		
	1	-	-	6	-	6	-	12	-	16	41	246		
	1	-	-	6	-	6	-	12	-	18	43	258		

TABLE LI. Wire rope and strand construction for special applications - Continued.

Construction	Center wires	Around center wires	Inside wires		Inside intermediate wires	Filler wires	Outside intermediate wires		Outside wires		Wires per strand	Total wires in rope	Sizes ¹	Type of lay
			Small	Large			Small	Large	Small	Large				
3-Seale-two operations	1	6	-	10	-	-	-	-	-	10	27	162	1 inch and smaller	Right or left regular
	1	6	-	12	-	-	-	-	-	12	31	186		
	1	6	-	14	-	-	-	-	-	14	35	210		
	1	6	-	15	-	-	-	-	-	15	37	222		
4-Filler wire	1	-	-	7	-	7	-	-	-	14	29	174	3/8 inch and larger	2
	1	-	-	8	-	8	-	-	-	16	33	198		
	1	-	-	9	-	9	-	-	-	18	37	222		
5-Seale-Warrington	1	-	7	-	7	-	-	-	7	7	29	174	3/8 inch and larger	Right or left regular
	1	-	8	-	8	-	-	-	8	8	33	198		
	1	-	9	-	9	-	-	-	9	9	37	222		
6-Warrington-Seale	1	-	-	9	-	-	9	9	-	18	46	276	All	2

TABLE LI. Wire rope and strand construction for special applications - Continued.

Construction	Center wires	Around center wires	Inside wires		Inside intermediate wires	Filler wires	Outside intermediate wires		Outside wires		Wires per strand	Total wires in rope	Sizes ¹	Type of lay
			Small	Large			Small	Large	Small	Large				
8-Filler wire- Seale	1	-	-	6	-	6	-	12	-	12	37	222	1/2 inch and larger	2
	1	-	-	7	-	7	-	14	-	14	43	258		
	1	-	-	8	-	8	-	16	-	16	49	294		
9-Seale-Warrington-Seale	1	-	7	-	7	-	7	7	-	14	43	258	2 inches and larger	2
Type I, general purpose, class 5, 6 by 61														
1- Three operations	1	6	6	6	-	-	-	14	-	20	53	318	2 inches and larger	Right or left regular
	1	6	6	6	-	-	-	16	-	22	57	342		
	1	6	6	6	-	-	-	18	-	24	61	366		
	1	9	-	9	-	-	-	14	-	20	53	318		
	1	9	-	9	-	-	-	16	-	22	57	342		
	1	9	-	9	-	-	-	18	-	24	61	366		

TABLE LI. Wire rope and strand construction for special applications - Continued.

Construction	Center wires	Around center wires	Inside wires		Inside intermediate wires	Filler wires	Outside intermediate wires		Outside wires		Wires per strand	Total wires in rope	Sizes ¹	Type of lay
			Small	Large			Small	Large	Small	Large				
1- Three operations	1	5	-	10	-	5	-	14	-	20	55	330	2 inches and larger	Right or left regular
	1	5	-	10	-	5	-	16	-	22	59	354		
	1	5	-	10	-	5	-	18	-	24	63	378		
	1	6	-	12	-	6	-	14	-	20	59	354		
	1	6	-	12	-	6	-	16	-	22	63	378		
	1	6	-	12	-	6	-	18	-	24	67	402		
	1	5	-	10	10	-	-	14	-	20	60	360		
	1	5	-	10	10	-	-	16	-	22	64	384		
	1	5	-	10	10	-	-	18	-	24	68	408		
2- Two operations	1	6	6	6	-	-	-	16	-	16	51	306	2 inches and larger	Right or left regular
	1	6	6	6	-	-	-	18	-	18	55	330		
	1	6	6	6	-	-	-	20	-	20	59	354		
	1	6	6	6	-	-	-	24	-	24	67	402		

TABLE LI. Wire rope and strand construction for special applications - Continued.

Construction	Center wires	Around center wires	Inside wires		Inside intermediate wires	Filler wires	Outside intermediate wires		Outside wires		Wires per strand	Total wires in rope	Sizes ¹	Type of lay
			Small	Large			Small	Large	Small	Large				
2- Two operations	1	9	-	9	-	-	-	16	-	16	51	306	2 inches and larger	Right or left regular
	1	9	-	9	-	-	-	18	-	18	55	330		
	1	9	-	9	-	-	-	20	-	20	59	354		
	1	9	-	9	-	-	-	24	-	24	67	402		
	1	5	-	10	-	5	-	16	-	16	53	318		
	1	5	-	10	-	5	-	18	-	18	57	342		
	1	5	-	10	-	5	-	20	-	20	61	366		
	1	5	-	10	-	5	-	24	-	24	69	414		
	1	6	-	12	-	6	-	16	-	16	57	342		
	1	6	-	12	-	6	-	18	-	18	61	366		
	1	6	-	12	-	6	-	20	-	20	65	390		
	1	6	-	12	-	6	-	24	-	24	73	438		

TABLE LI. Wire rope and strand construction for special applications - Continued.

Construction	Center wires	Around center wires	Inside wires		Inside intermediate wires	Filler wires	Outside intermediate wires		Outside wires		Wires per strand	Total wires in rope	Sizes ¹	Type of lay
			Small	Large			Small	Large	Small	Large				
2- Two operations	1	5	-	10	10	-	-	16	-	16	58	348	2 inches and larger	Right or left regular
	1	5	-	10	10	-	-	18	-	18	62	372		
	1	5	-	10	10	-	-	20	-	20	66	396		
	1	5	-	10	10	-	-	24	-	24	74	444		
3- Two operations	1	7	-	14	-	7	-	-	-	22	51	306	2 inches and larger	Right or left regular
	1	7	-	14	-	7	-	-	-	24	53	318		
	1	8	-	16	-	8	-	-	-	20	53	318		
	1	8	-	16	-	8	-	-	-	22	55	330		
	1	8	-	16	-	8	-	-	-	24	57	342		
	1	9	-	18	-	9	-	-	-	20	57	342		
	1	9	-	18	-	9	-	-	-	22	59	354		
	1	9	-	18	-	9	-	-	-	24	61	366		

TABLE LI. Wire rope and strand construction for special applications - Continued.

Construction	Center wires	Around center wires	Inside wires		Inside intermediate wires	Filler wires	Outside intermediate wires		Outside wires		Wires per strand	Total wires in rope	Sizes ¹	Type of lay	
			Small	Large			Small	Large	Small	Large					
3- Two operations	1	7	-	7	-	-	7	7	-	22	51	306	2 inches and larger	Right or left regular	
	1	7	-	7	-	-	7	7	-	24	53	318			
	1	8	-	8	-	-	8	8	-	20	53	318			
	1	8	-	8	-	-	8	8	-	22	55	330			
	1	8	-	8	-	-	8	8	-	24	57	342			
	1	9	-	9	-	-	9	9	-	20	57	342			
	1	9	-	9	-	-	9	9	-	22	59	354			
	1	9	-	9	-	-	9	9	-	24	61	366			
	1	6	6	6	6	-	-	-	12	-	20	51			306
	1	6	6	6	6	-	-	-	12	-	24	55			330
	1	7	7	7	7	-	-	-	14	-	16	52			312
	1	7	7	7	7	-	-	-	14	-	18	54			324

TABLE LI. Wire rope and strand construction for special applications - Continued.

Construction	Center wires	Around center wires	Inside wires		Inside intermediate wires	Filler wires	Outside intermediate wires		Outside wires		Wires per strand	Total wires in rope	Sizes ¹	Type of lay
			Small	Large			Small	Large	Small	Large				
3- Two operations	1	7	7	7	-	-	-	14	-	20	56	336	2 inches and larger	Right or left regular
	1	7	7	7	-	-	-	14	-	24	60	360		
	1	8	8	8	-	-	-	16	-	16	57	342		
	1	8	8	8	-	-	-	16	-	18	59	354		
	1	8	8	8	-	-	-	16	-	20	61	366		
	1	8	8	8	-	-	-	16	-	24	65	390		
	1	9	9	9	-	-	-	18	-	16	62	372		
	1	9	9	9	-	-	-	18	-	18	64	384		
	1	9	9	9	-	-	-	18	-	20	66	396		
	1	9	9	9	-	-	-	18	-	24	70	420		
	1	7	-	7	-	7	-	14	-	16	52	312		
	1	7	-	7	-	7	-	14	-	18	54	324		
	1	7	-	7	-	7	-	14	-	20	56	336		

TABLE LI. Wire rope and strand construction for special applications - Continued.

Construction	Center wires	Around center wires	Inside wires		Inside intermediate wires	Filler wires	Outside intermediate wires		Outside wires		Wires per strand	Total wires in rope	Sizes ¹	Type of lay
			Small	Large			Small	Large	Small	Large				
3- Two operations	1	7	-	7	-	7	-	14	-	24	60	360	2 inches and larger	Right or left regular
	1	8	-	8	-	8	-	16	-	16	57	342		
	1	8	-	8	-	8	-	16	-	18	59	354		
	1	8	-	8	-	8	-	16	-	20	61	366		
	1	8	-	8	-	8	-	16	-	24	65	390		
	1	9	-	9	-	9	-	18	-	16	62	372		
	1	9	-	9	-	9	-	18	-	18	64	384		
	1	9	-	9	-	9	-	18	-	20	66	396		
	1	9	-	9	-	9	-	18	-	24	70	420		
	1	5	-	10	-	5	-	10	-	20	51	306		
	1	5	-	10	-	5	-	10	-	24	55	330		
	1	6	-	12	-	6	-	12	-	16	53	318		
	1	6	-	12	-	6	-	12	-	18	55	330		

TABLE LI. Wire rope and strand construction for special applications - Continued.

Construction	Center wires	Around center wires	Inside wires		Inside intermediate wires	Filler wires	Outside intermediate wires		Outside wires		Wires per strand	Total wires in rope	Sizes ¹	Type of lay
			Small	Large			Small	Large	Small	Large				
3- Two operations	1	6	-	12	-	6	-	12	-	20	57	342	2 inches and larger	Right or left regular
	1	6	-	12	-	6	-	12	-	24	61	366		
	1	7	-	14	-	7	-	14	-	16	59	354		
	1	7	-	14	-	7	-	14	-	18	61	366		
	1	7	-	14	-	7	-	14	-	20	63	378		
	1	7	-	14	-	7	-	14	-	24	67	402		
	1	8	-	16	-	8	-	16	-	16	65	390		
	1	8	-	16	-	8	-	16	-	18	67	402		
	1	8	-	16	-	8	-	16	-	20	69	414		
	1	8	-	16	-	8	-	16	-	24	73	438		
4- Filler wire- Seale	1	6	-	9	-	9	-	18	-	18	61	366	2 inches and larger	Right or left regular

99

RR-W-410E

TABLE LI. Wire rope and strand construction for special applications - Continued.

Construction	Center wires	Around center wires	Inside wires		Inside intermediate wires	Filler wires	Outside intermediate wires		Outside wires		Wires per strand	Total wires in rope	Sizes ¹	Type of lay
			Small	Large			Small	Large	Small	Large				
6- Seale-Filler wire-Seale	1	8	-	8	-	8	-	16	-	16	57	342	2 inches and larger	Right or left regular
	Type I, general purpose, class 6, 6 by 91													
1- Four operations	1	6	6	6	-	-	-	14	20	26	79	474	2.5 inches and larger	Right or left regular
	1	6	6	6	-	-	-	16	22	28	85	510		
	1	6	6	6	-	-	-	18	24	30	91	546		
	1	9	-	9	-	-	-	14	20	26	79	474		
	1	9	-	9	-	-	-	16	22	28	85	510		
	1	9	-	9	-	-	-	18	24	30	91	546		
	1	5	-	10	-	5	-	14	20	26	81	486		
	1	5	-	10	-	5	-	16	22	28	87	522		
	1	5	-	10	-	5	-	18	24	30	93	558		
	1	6	-	12	-	6	-	14	20	26	85	510		
1	6	-	12	-	6	-	16	22	28	91	546			
1	6	-	12	-	6	-	18	24	30	97	582			

TABLE LI. Wire rope and strand construction for special applications - Continued.

Construction	Center wires	Around center wires	Inside wires		Inside intermediate wires	Filler wires	Outside intermediate wires		Outside wires		Wires per strand	Total wires in rope	Sizes ¹	Type of lay
			Small	Large			Small	Large	Small	Large				
1- Four operations	1	5	5	5	10	-	-	14	20	26	86	516	2.5 inches and larger	Right or left regular
	1	5	5	5	10	-	-	16	22	28	92	552		
	1	5	5	5	10	-	-	18	24	30	98	588		
2- Three operations	1	6	6	6	-	-	-	16	22	22	79	474	2.5 inches and larger	Right or left regular
	1	6	6	6	-	-	-	18	24	24	85	510		
	1	6	6	6	-	-	-	20	26	26	91	546		
	1	6	6	6	-	-	-	24	30	30	103	618		
	1	9	-	9	-	-	-	16	22	22	79	474		
	1	9	-	9	-	-	-	18	24	24	85	510		
	1	9	-	9	-	-	-	20	26	26	91	546		
	1	9	-	9	-	-	-	24	30	30	103	618		
	1	5	-	10	-	5	-	16	22	22	81	486		
	1	5	-	10	-	5	-	18	24	24	87	522		

TABLE LI. Wire rope and strand construction for special applications - Continued.

Construction	Center wires	Around center wires	Inside wires		Inside intermediate wires	Filler wires	Outside intermediate wires		Outside wires		Wires per strand	Total wires in rope	Sizes ¹	Type of lay
			Small	Large			Small	Large	Small	Large				
2- Three operations	1	5	-	10	-	5	-	20	26	26	93	558	2.5 inches and larger	Right or left regular
	1	5	-	10	-	5	-	24	30	30	105	630		
	1	6	-	12	-	6	-	16	22	22	85	510		
	1	6	-	12	-	6	-	18	24	24	91	546		
	1	6	-	12	-	6	-	20	26	26	97	582		
	1	6	-	12	-	6	-	24	30	30	109	654		
	1	5	5	5	10	-	-	16	22	22	86	516		
	1	5	5	5	10	-	-	18	24	24	92	552		
	1	5	5	5	10	-	-	20	26	26	98	588		
	1	5	5	5	10	-	-	24	30	30	110	660		
3- Three operations	1	7	-	14	-	7	-	-	20	26	75	450	2.5 inches and larger	Right or left regular
	1	7	-	14	-	7	-	-	22	28	79	474		
	1	7	-	14	-	7	-	-	24	30	83	498		

TABLE LI. Wire rope and strand construction for special applications - Continued.

Construction	Center wires	Around center wires	Inside wires		Inside intermediate wires	Filler wires	Outside intermediate wires		Outside wires		Wires per strand	Total wires in rope	Sizes ¹	Type of lay
			Small	Large			Small	Large	Small	Large				
3- Three operations	1	8	-	16	-	8	-	-	20	26	79	474	2.5 inches and larger	Right or left regular
	1	8	-	16	-	8	-	-	22	28	83	498		
	1	8	-	16	-	8	-	-	24	30	87	522		
	1	9	-	18	-	9	-	-	20	26	83	498		
	1	9	-	18	-	9	-	-	22	28	87	522		
	1	9	-	18	-	9	-	-	24	30	91	546		
	1	7	-	7	-	-	7	7	20	26	75	450		
	1	7	-	7	-	-	7	7	22	28	79	474		
	1	7	-	7	-	-	7	7	24	30	83	498		
	1	8	-	8	-	-	8	8	20	26	79	474		
	1	8	-	8	-	-	8	8	22	28	83	498		
	1	8	-	8	-	-	8	8	24	30	87	522		

TABLE LI. Wire rope and strand construction for special applications - Continued.

Construction	Center wires	Around center wires	Inside wires		Inside intermediate wires	Filler wires	Outside intermediate wires		Outside wires		Wires per strand	Total wires in rope	Sizes ¹	Type of lay
			Small	Large			Small	Large	Small	Large				
3- Three operations	1	9	-	9	-	-	9	9	20	26	83	498	2.5 inches and larger	Right or left regular
	1	9	-	9	-	-	9	9	22	28	87	522		
	1	9	-	9	-	-	9	9	24	30	91	546		
	1	6	6	6	-	-	-	12	20	26	77	462		
	1	6	6	6	-	-	-	12	22	28	81	486		
	1	6	6	6	-	-	-	12	24	30	85	510		
	1	7	7	7	-	-	-	14	20	26	82	492		
	1	7	7	7	-	-	-	14	22	28	86	516		
	1	7	7	7	-	-	-	14	24	30	90	540		
	1	8	8	8	-	-	-	16	20	26	87	522		
	1	8	8	8	-	-	-	16	22	28	91	546		
	1	8	8	8	-	-	-	16	24	30	95	570		

TABLE LI. Wire rope and strand construction for special applications - Continued.

Construction	Center wires	Around center wires	Inside wires		Inside intermediate wires	Filler wires	Outside intermediate wires		Outside wires		Wires per strand	Total wires in rope	Sizes ¹	Type of lay
			Small	Large			Small	Large	Small	Large				
3- Three operations	1	9	9	9	-	-	-	18	20	26	92	552	2.5 inches and larger	Right or left regular
	1	9	9	9	-	-	-	18	22	28	96	576		
	1	9	9	9	-	-	-	18	24	30	100	600		
	1	7	-	7	-	7	-	14	20	26	82	492		
	1	7	-	7	-	7	-	14	22	28	86	516		
	1	7	-	7	-	7	-	14	24	30	90	540		
	1	8	-	8	-	8	-	16	20	26	87	522		
	1	8	-	8	-	8	-	16	22	28	91	546		
	1	8	-	8	-	8	-	16	24	30	95	570		
	1	9	-	9	-	9	-	18	20	26	92	552		
	1	9	-	9	-	9	-	18	22	28	96	576		
	1	9	-	9	-	9	-	18	24	30	100	600		

TABLE LI. Wire rope and strand construction for special applications - Continued.

Construction	Center wires	Around center wires	Inside wires		Inside intermediate wires	Filler wires	Outside intermediate wires		Outside wires		Wires per strand	Total wires in rope	Sizes ¹	Type of lay
			Small	Large			Small	Large	Small	Large				
3- Three operations	1	5	-	10	-	5	-	10	20	26	77	462	2.5 inches and larger	Right or left regular
	1	5	-	10	-	5	-	10	22	28	81	486		
	1	5	-	10	-	5	-	10	24	30	85	510		
	1	6	-	12	-	6	-	12	20	26	83	498		
	1	6	-	12	-	6	-	12	22	28	87	522		
	1	6	-	12	-	6	-	12	24	30	91	546		
	1	7	-	14	-	7	-	14	20	26	89	534		
	1	7	-	14	-	7	-	14	22	28	93	558		
	1	7	-	14	-	7	-	14	24	30	97	582		
	1	8	-	16	-	8	-	16	20	26	95	570		
	1	8	-	16	-	8	-	16	22	28	99	594		
	1	8	-	16	-	8	-	16	24	30	103	618		

TABLE LI. Wire rope and strand construction for special applications - Continued.

Construction	Center wires	Around center wires	Inside wires		Inside intermediate wires	Filler wires	Outside intermediate wires		Outside wires		Wires per strand	Total wires in rope	Sizes ¹	Type of lay
			Small	Large			Small	Large	Small	Large				
4- Two operations	1	7	-	14	-	7	-	-	24	24	77	462	2.5 inches and larger	Right or left regular
	1	7	-	14	-	7	-	-	26	26	81	486		
	1	7	-	14	-	7	-	-	30	30	89	534		
	1	8	-	16	-	8	-	-	22	22	77	462		
	1	8	-	16	-	8	-	-	24	24	81	486		
	1	8	-	16	-	8	-	-	26	26	85	510		
	1	8	-	16	-	8	-	-	30	30	93	558		
	1	9	-	18	-	9	-	-	22	22	81	486		
	1	9	-	18	-	9	-	-	24	24	85	510		
	1	9	-	18	-	9	-	-	26	26	89	534		
	1	9	-	18	-	9	-	-	30	30	97	582		
	1	7	-	7	-	-	7	7	24	24	77	462		
	1	7	-	7	-	-	7	7	26	26	81	486		

TABLE LI. Wire rope and strand construction for special applications - Continued.

Construction	Center wires	Around center wires	Inside wires		Inside intermediate wires	Filler wires	Outside intermediate wires		Outside wires		Wires per strand	Total wires in rope	Sizes ¹	Type of lay	
			Small	Large			Small	Large	Small	Large					
4- Two operations	1	7	-	7	-	-	7	7	30	30	89	534	2.5 inches and larger	Right or left regular	
	1	8	-	8	-	-	8	8	22	22	77	462			
	1	8	-	8	-	-	8	8	24	24	81	486			
	1	8	-	8	-	-	8	8	26	26	85	510			
	1	8	-	8	-	-	8	8	30	30	93	558			
	1	9	-	9	-	-	9	9	22	22	81	486			
	1	9	-	9	-	-	9	9	24	24	85	510			
	1	9	-	9	-	-	9	9	26	26	89	534			
	1	9	-	9	-	-	9	9	30	30	97	582			
	1	6	6	6	6	-	-	-	12	22	22	75			450
	1	6	6	6	6	-	-	-	12	24	24	79			474
	1	6	6	6	6	-	-	-	12	26	26	83			498
	1	6	6	6	6	-	-	-	12	30	30	91			546

TABLE LI. Wire rope and strand construction for special applications - Continued.

Construction	Center wires	Around center wires	Inside wires		Inside intermediate wires	Filler wires	Outside intermediate wires		Outside wires		Wires per strand	Total wires in rope	Sizes ¹	Type of lay
			Small	Large			Small	Large	Small	Large				
4- Two operations	1	7	7	7	-	-	-	14	22	22	80	480	2.5 inches and larger	Right or left regular
	1	7	7	7	-	-	-	14	24	24	84	504		
	1	7	7	7	-	-	-	14	26	26	88	528		
	1	7	7	7	-	-	-	14	30	30	96	576		
	1	8	8	8	-	-	-	16	22	22	85	510		
	1	8	8	8	-	-	-	16	24	24	89	534		
	1	8	8	8	-	-	-	16	26	26	93	558		
	1	8	8	8	-	-	-	16	30	30	101	606		
	1	9	9	9	-	-	-	18	22	22	90	540		
	1	9	9	9	-	-	-	18	24	24	94	564		
	1	9	9	9	-	-	-	18	26	26	98	588		
	1	9	9	9	-	-	-	18	30	30	106	636		

TABLE LI. Wire rope and strand construction for special applications - Continued.

Construction	Center wires	Around center wires	Inside wires		Inside intermediate wires	Filler wires	Outside intermediate wires		Outside wires		Wires per strand	Total wires in rope	Sizes ¹	Type of lay
			Small	Large			Small	Large	Small	Large				
4- Two operations	1	7	-	7	-	7	-	14	22	22	80	480	2.5 inches and larger	Right or left regular
	1	7	-	7	-	7	-	14	24	24	84	504		
	1	7	-	7	-	7	-	14	26	26	88	528		
	1	7	-	7	-	7	-	14	30	30	96	576		
	1	8	-	8	-	8	-	16	22	22	85	510		
	1	8	-	8	-	8	-	16	24	24	89	534		
	1	8	-	8	-	8	-	16	26	26	93	558		
	1	8	-	8	-	8	-	16	30	30	101	606		
	1	9	-	9	-	9	-	18	22	22	90	540		
	1	9	-	9	-	9	-	18	24	24	94	564		
	1	9	-	9	-	9	-	18	26	26	98	588		
	1	9	-	9	-	9	-	18	30	30	106	636		

TABLE LI. Wire rope and strand construction for special applications - Continued.

Construction	Center wires	Around center wires	Inside wires		Inside intermediate wires	Filler wires	Outside intermediate wires		Outside wires		Wires per strand	Total wires in rope	Sizes ¹	Type of lay
			Small	Large			Small	Large	Small	Large				
4- Two operations	1	5	-	10	-	5	-	10	22	22	75	450	2.5 inches and larger	Right or left regular
	1	5	-	10	-	5	-	10	24	24	79	474		
	1	5	-	10	-	5	-	10	26	26	83	498		
	1	5	-	10	-	5	-	10	30	30	91	546		
	1	6	-	12	-	6	-	12	22	22	81	486		
	1	6	-	12	-	6	-	12	24	24	85	510		
	1	6	-	12	-	6	-	12	26	26	89	534		
	1	6	-	12	-	6	-	12	30	30	97	582		
	1	7	-	14	-	7	-	14	22	22	87	522		
	1	7	-	14	-	7	-	14	24	24	91	546		
	1	7	-	14	-	7	-	14	26	26	95	570		
	1	7	-	14	-	7	-	14	30	30	103	618'		

TABLE LI. Wire rope and strand construction for special applications - Continued.

Construction	Center wires	Around center wires	Inside wires		Inside intermediate wires	Filler wires	Outside intermediate wires		Outside wires		Wires per strand	Total wires in rope	Sizes ¹	Type of lay		
			Small	Large			Small	Large	Small	Large						
4- Two operations	1	8	-	16	-	8	-	16	22	22	93	558	2.5 inches and larger	Right or left regular		
	1	8	-	16	-	8	-	16	24	24	97	582				
	1	8	-	16	-	8	-	16	26	26	101	606				
	1	8	-	16	-	8	-	16	30	30	109	654				
-	F	-	-	-	Type III, marine, class 1, 6 by 6 deck lashing						6	6	36	All	Right regular	
-	F	-	-	-	Type III, class 2, 6 by 12 running rope						12	12	72	All	Right regular	
1- Two operations	F	-	-	9	Type III, class 3, 6 by 24 mooring line						15	24	144	All	Right regular	
2-Warrington	F	-	-	8							8	8	24	144		All
3-Seale	F	-	-	12							12	24	144	All		

TABLE LI. Wire rope and strand construction for special applications - Continued.

Construction	Center wires	Around center wires	Inside wires		Inside intermediate wires	Filler wires	Outside intermediate wires		Outside wires		Wires per strand	Total wires in rope	Sizes ¹	Type of lay		
			Small	Large			Small	Large	Small	Large						
-	1	-	-	-	Type III, class 4, 6 by 3 by 7 spring lay		-	-	-	-	6	7	126	All	Right regular	
1- Two operations	1	-	-	6	Type III, class 5, 6 by 3 by 19 spring lay		-	-	-	-	12	19	342	All	Right regular	
2-Warrington	1	-	-	6	-	-	-	-	6	6	19	342	All	Right regular		
3-Seale	1	9	-	-	-	-	-	-	-	9	19	342	All	Right regular		
2-Warrington-Seale	1	-	-	5	Type IV, class 4, 8 by 19 rotation resistant		-	-	5	5	-	10	26	208	All	Right regular

¹Sizes refer to those listed in the respective tables for each type and class of rope.

²Wire rope with fiber core shall be supplied with right regular lay. Wire rope with wire strand core or IWRC may be supplied with right or left regular lay or right or left lang lay.

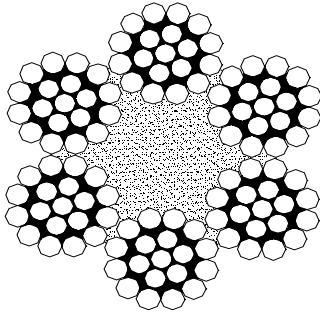

FIGURE 1. Fiber core.

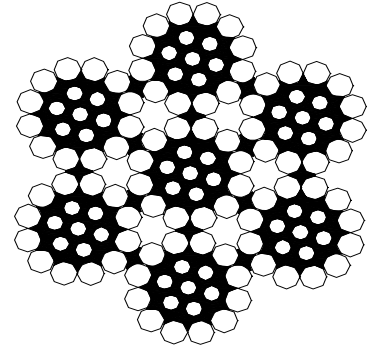

FIGURE 2. Wire strand core.

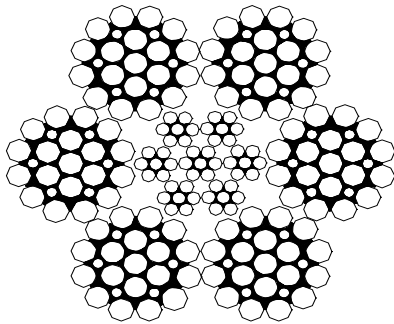

FIGURE 3. Independent wire-rope core (IWRC).

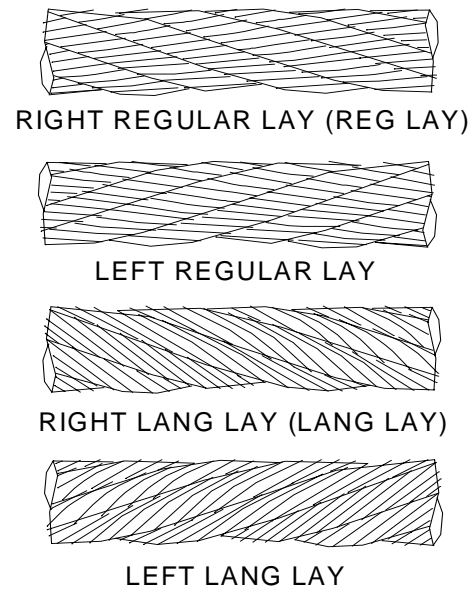

FIGURE 4. Lays in wire rope.

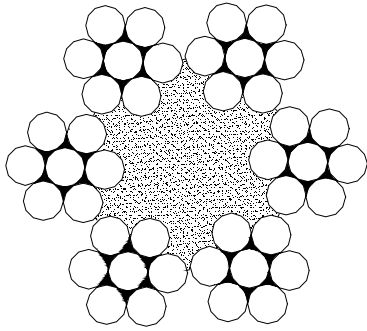

FIGURE 5. Type I, general purpose, class 1, 6 by 7.

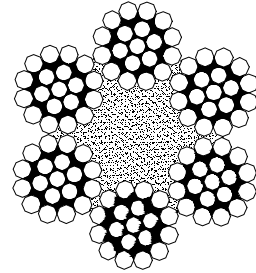

FIGURE 6. Type I, general purpose, class 2, construction 1, 6 by 19 (2 operations).

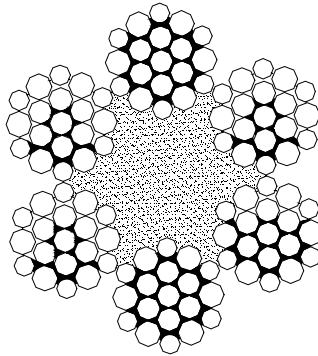

FIGURE 7. Type I, general purpose, class 2, construction 2, 6 by 19 (Warrington) and type II, elevator, class 1, construction 1, 6 by 19 (Warrington).

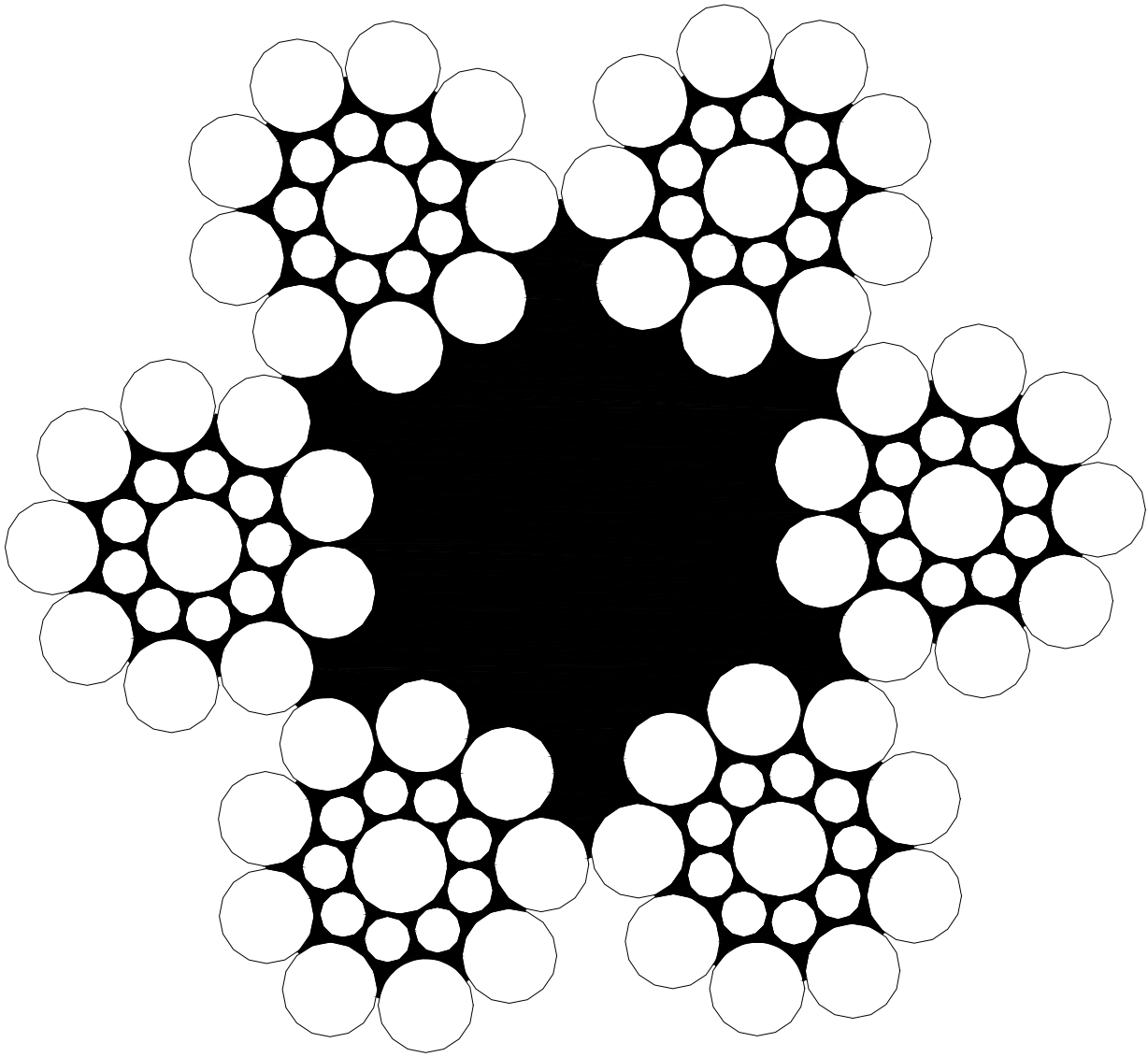

FIGURE 8. Type I, general purpose, class 2, construction 3, 6 by 19 (Seale).

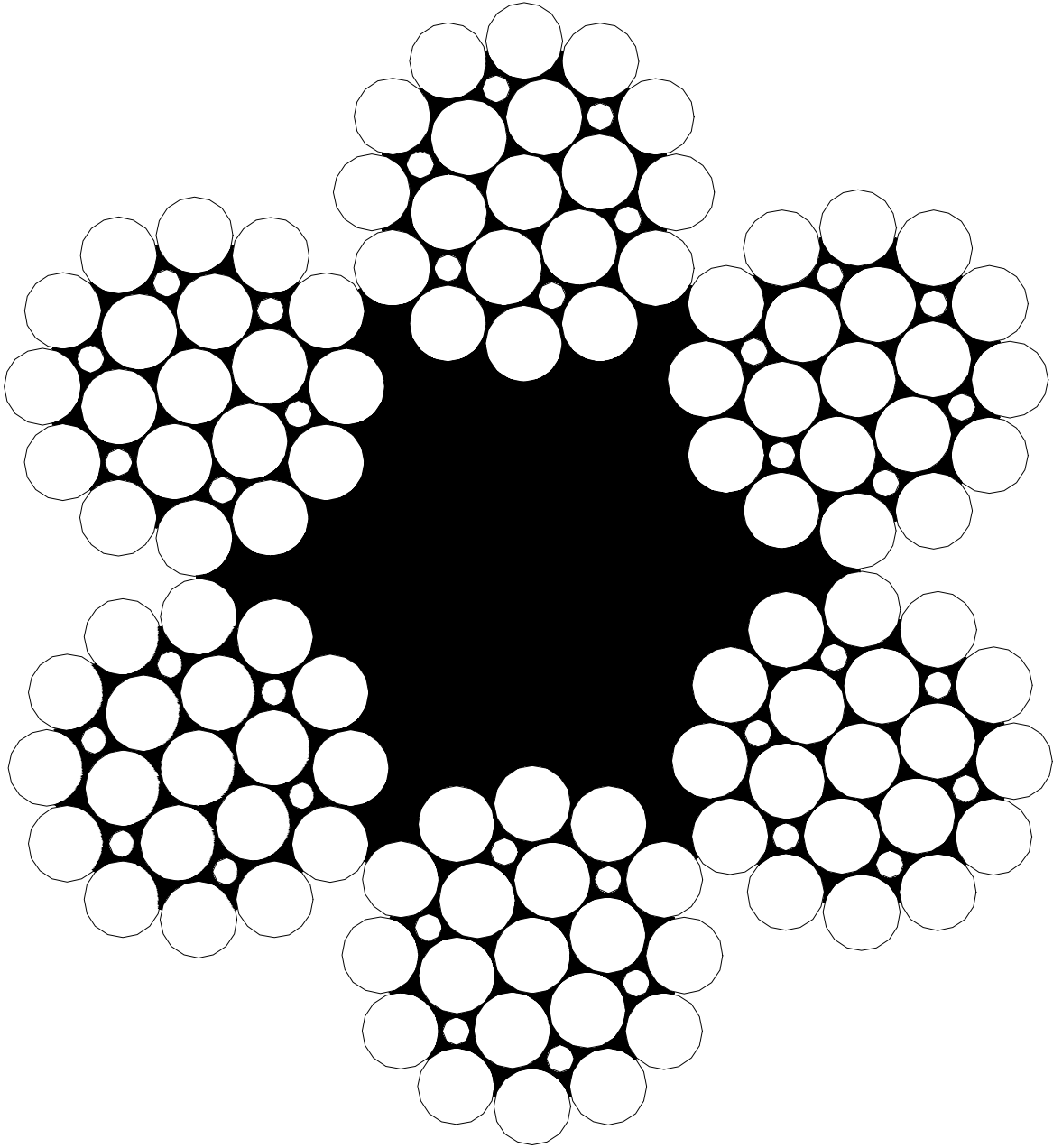

FIGURE 9. Type I, general purpose, class 2, construction 4, 6 by 19 (Filler wire), and type II, elevator, class 1, construction 2, 6 by 19 (Filler wire).

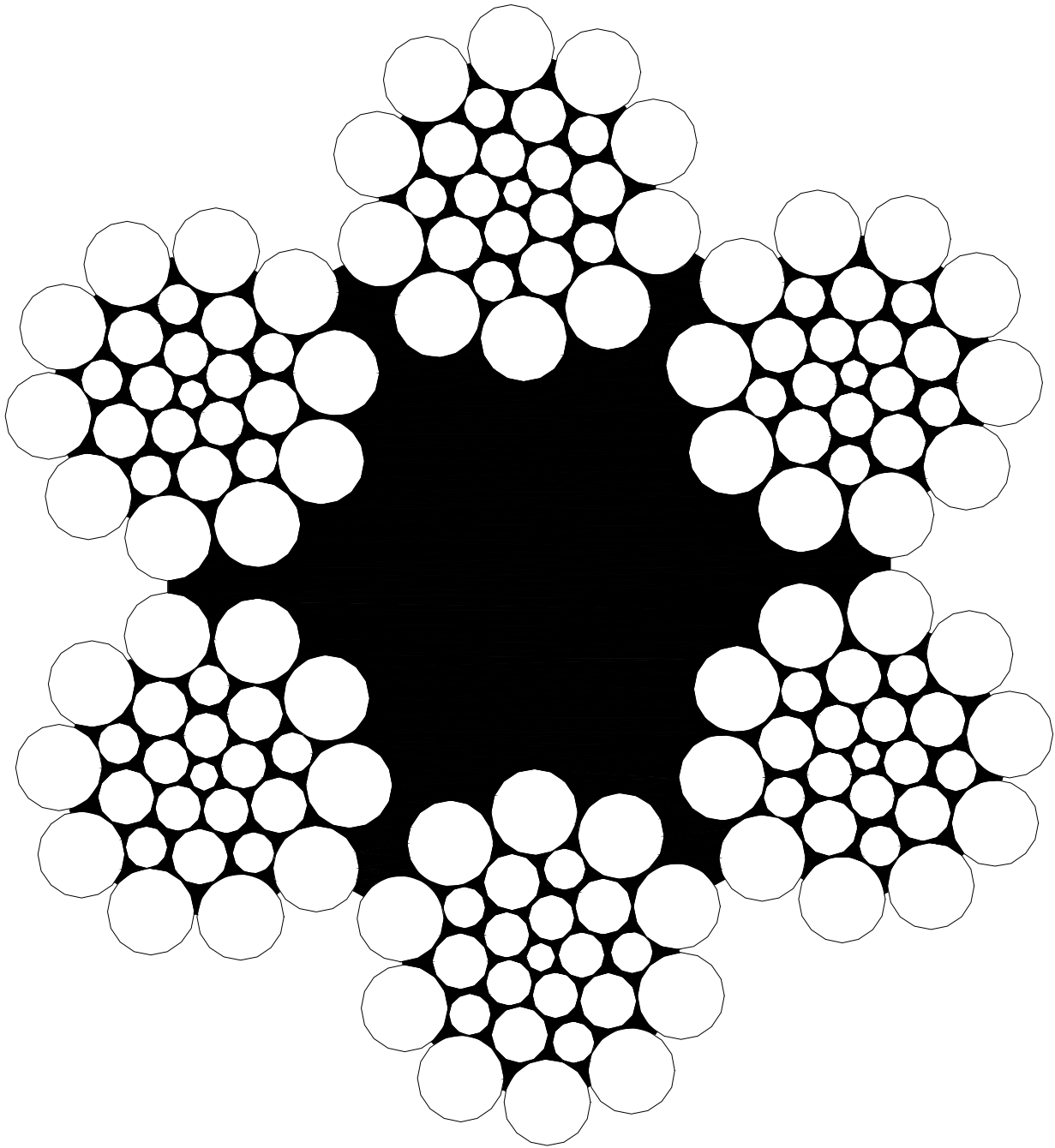

FIGURE 10. Type I, general purpose, class 2, construction 5, 6 by 19 (Warrington-Seale), and type II, elevator, class 1, construction 3, 6 by 19 (Warrington-Seale).

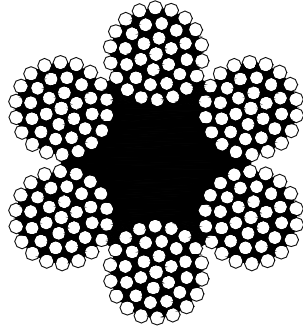

FIGURE 11. Type I, general purpose, class 3, construction 1, 6 by 37 (3 operations).

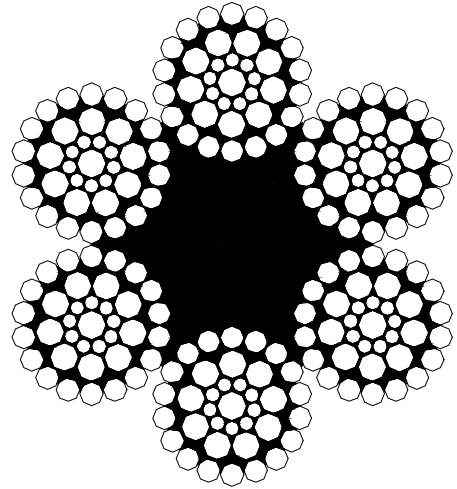

FIGURE 12. Type I, general purpose, class 3, construction 2, 6 by 37 (2 operations).

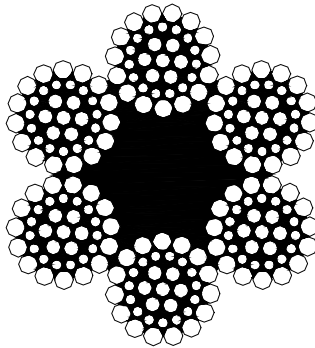

FIGURE 13. Type I, general purpose, class 3, construction 3, 6 by 37 (Seale) (2 operations).

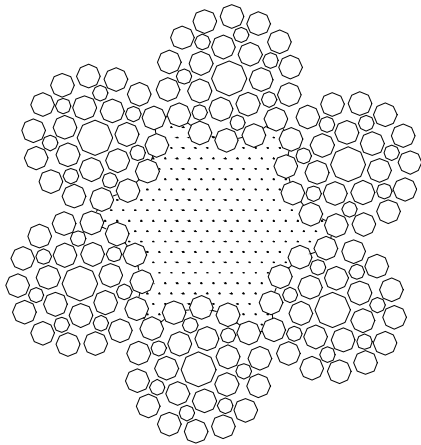

FIGURE 14. Type I, general purpose,
class 3, construction 4,
6 by 37 (Filler wire).

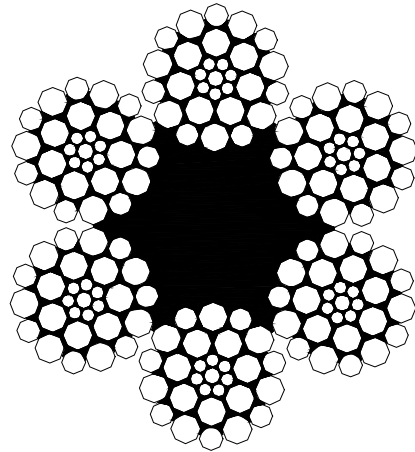

FIGURE 15. Type I, general purpose,
class 3, construction 5,
6 by 37 (Seale-Warrington).

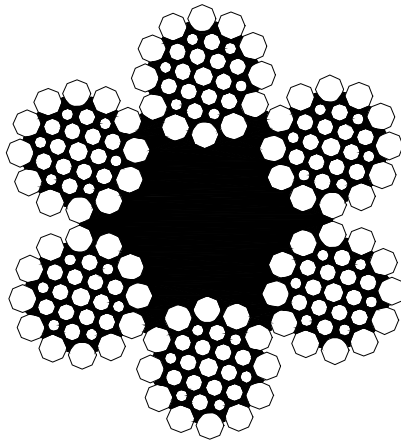

FIGURE 16. Type I, general purpose, class 3, construction 6,
6 by 37 (Warrington-Seale).

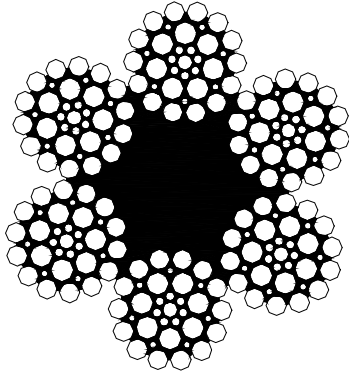

FIGURE 17. Type I, general purpose, class 3, construction 7, 6 by 37 (Seale-Filler wire).

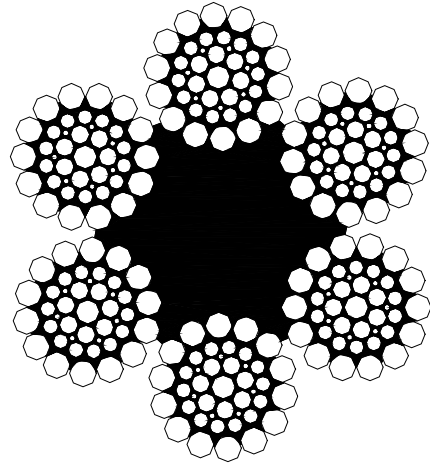

FIGURE 18. Type I, general purpose, class 3, construction 8, 6 by 37 (Filler wire-Seale).

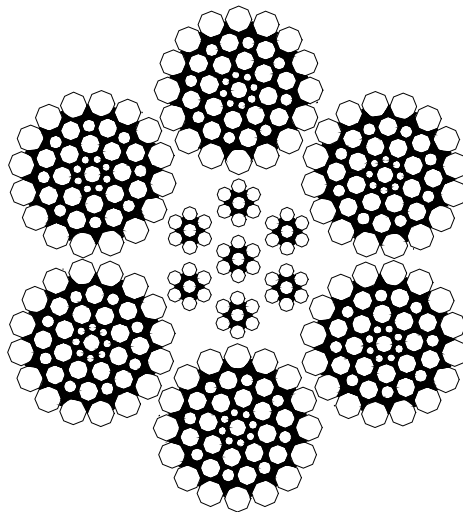

FIGURE 19. Type I, general purpose, class 3, construction 9, 6 by 37 (Seale-Warrington-Seale).

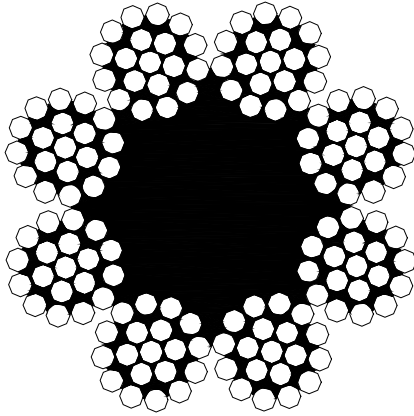

FIGURE 20. Type I, general purpose, class 4, construction 1, 8 by 19 (2 operations) and type II, elevator, class 2, construction 1, 8 by 19 (2 operations).

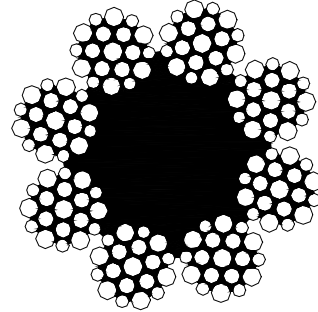

FIGURE 21. Type I, general purpose, class 4, construction 2, 8 by 19 (Warrington) and type II, elevator, class 2, construction 2, 8 by 19 (Warrington).

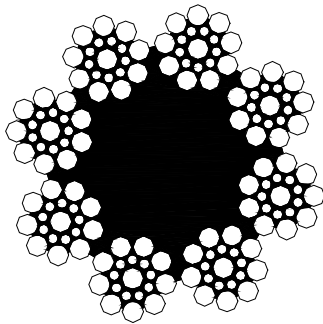

FIGURE 22. Type I, general purpose, class 4, construction 3, 8 by 19 (Seale) and type II, elevator, class 2, construction 3, 8 by 19 (Seale).

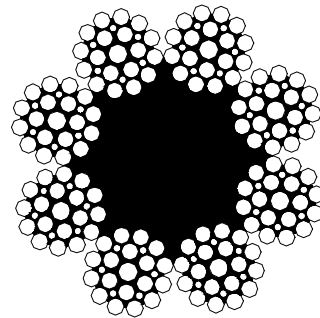

FIGURE 23. Type I, general purpose, class 4, construction 4, 8 by 19 (Filler wire) and type II, elevator, class 2, construction 4, 8 by 19 (Filler wire).

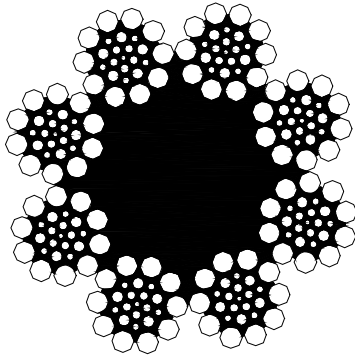

FIGURE 24. Type I, general purpose, class 4, construction 5, 8 by 19 (Warrington-Seale) and type II, elevator, class 2, construction 5, 8 by 19 (Warrington-Seale).

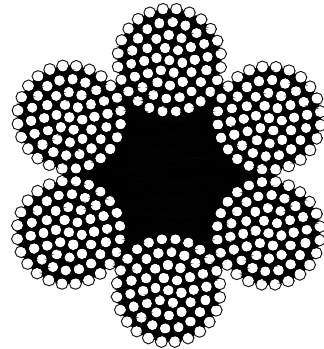

FIGURE 25. Type I, general purpose, class 5, 6 by 61.

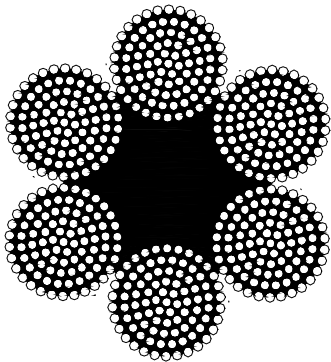

FIGURE 26. Type I, general purpose, class 6, 6 by 91.

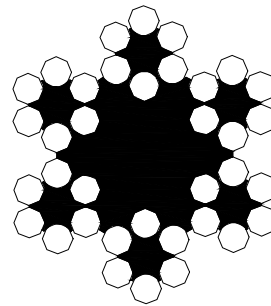

FIGURE 27. Type III, marine (cables), class 1, 6 by 6, (deck lashing ropes).

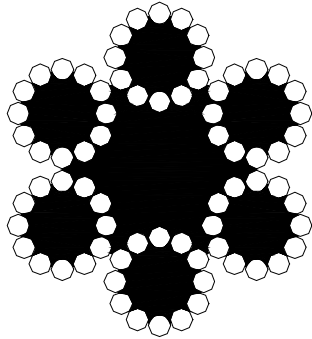

FIGURE 28. Type III, marine (cables), class 2, 6 by 12 (running ropes).

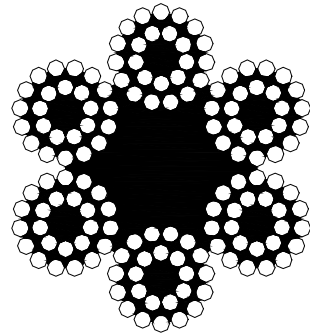

FIGURE 29. Type III, marine (cables), class 3, 6 by 24 (mooring lines), construction 1, (2 operations).

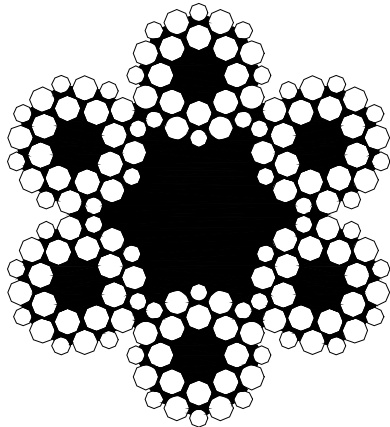

FIGURE 30. Type III, marine (cables), class 3, 6 by 24 mooring lines, construction 2, (Warrington).

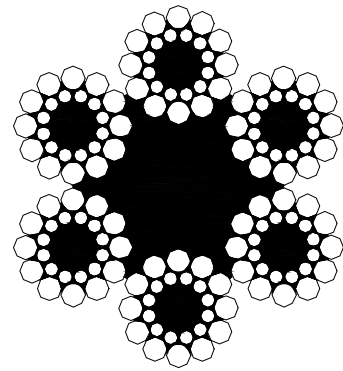

FIGURE 31. Type III, marine (cables), class 3, 6 by 24, (mooring lines), construction 3, (Seale).

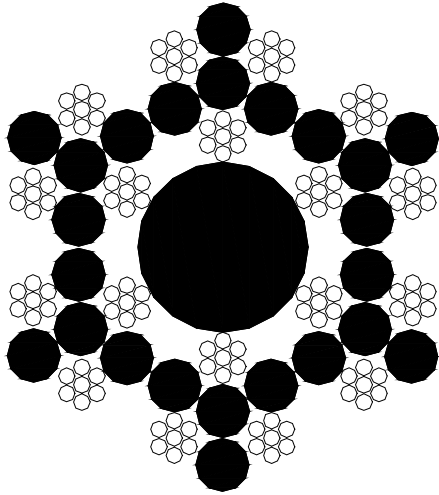

FIGURE 32. Type III, marine (cables),
class 4, 6 by 3 by 7
spring lay.

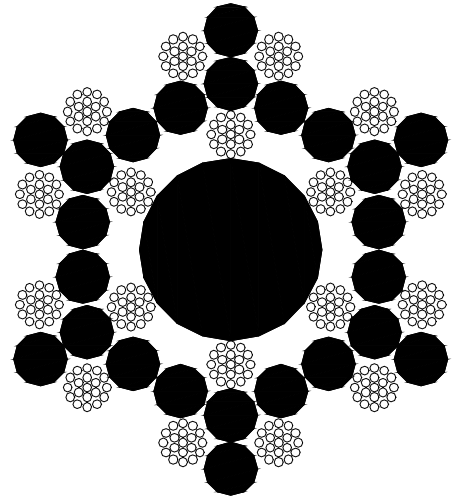

FIGURE 33. Type III, marine (cables),
class 5, 6 by 3 by 19
spring lay, construction 1,
(2 operations).

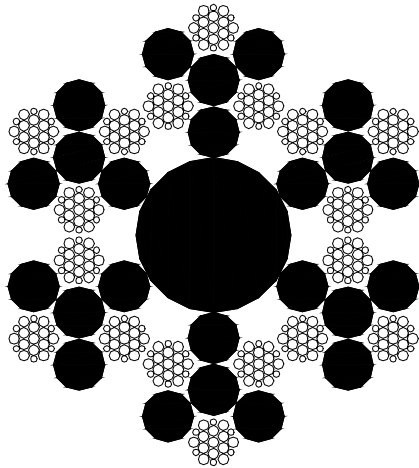

FIGURE 34. Type III, marine (cables),
class 5, 6 by 3 by 19
spring lay, construction 2,
(Warrington).

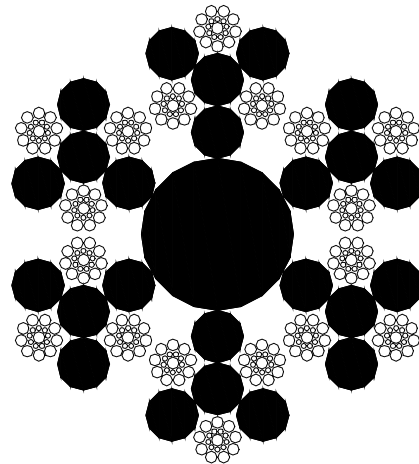

FIGURE 35. Type III, marine (cables),
class 5, 6 by 3 by 19
spring lay, construction 3,
(Seale).

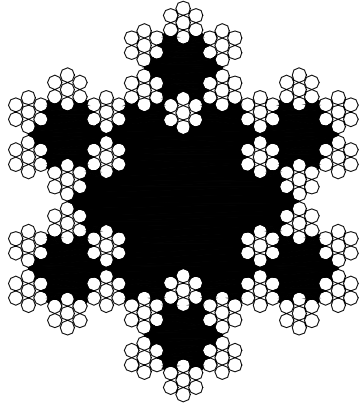

FIGURE 36. Type III, marine (cables), class 6, 6 by 42 tiller or hand control ropes.

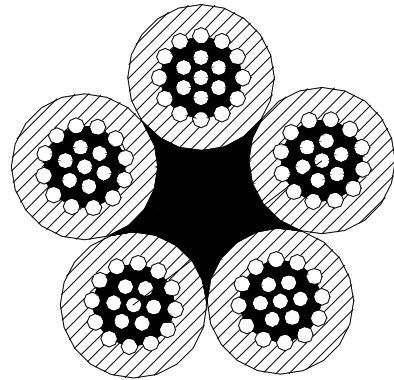

FIGURE 37. Type IV, miscellaneous, class 1, 5 by 19 (marine-clad), construction 1 (2 operations).

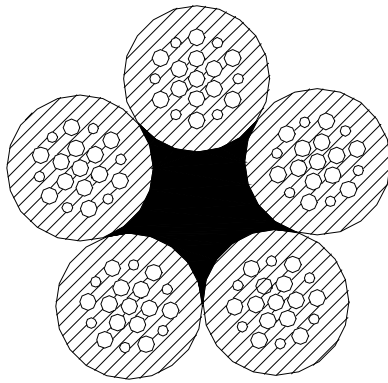

FIGURE 38. Type IV, miscellaneous, class 1, 5 by 19 (marine-clad), construction 2, (Warrington).

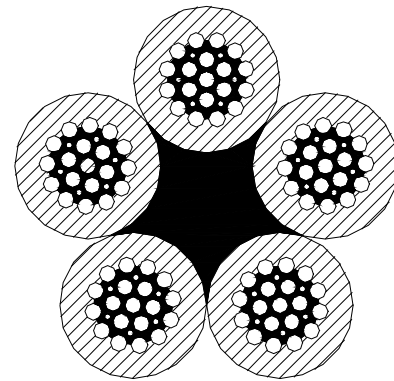

FIGURE 39. Type IV, miscellaneous, class 1, 5 by 19 (marine-clad), construction 3, (Filler wire).

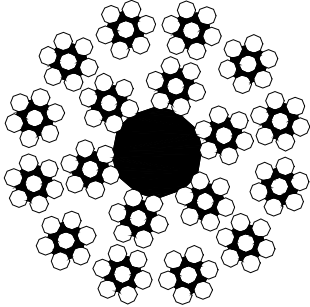

FIGURE 40. Type IV, miscellaneous,
class 2, 18 by 7
rotation - resistant.

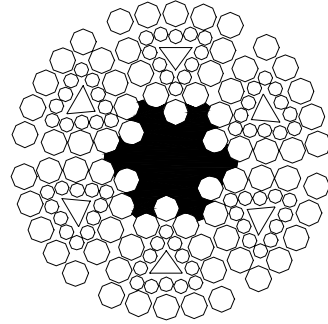

FIGURE 41. Type IV, miscellaneous,
class 3, flattened
strand, construction 1,
6 by 25, style B.

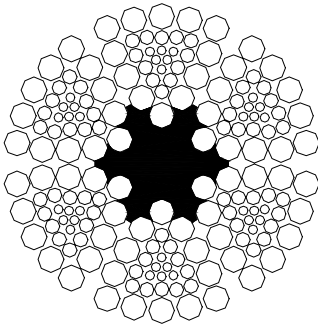

FIGURE 42. Type IV, miscellaneous,
class 3, flattened
strand, construction 2,
6 by 30, style G.

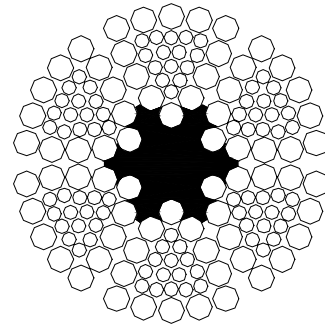

FIGURE 43. Type IV, miscellaneous,
class 3, flattened
strand, construction 3,
6 by 27, style H.

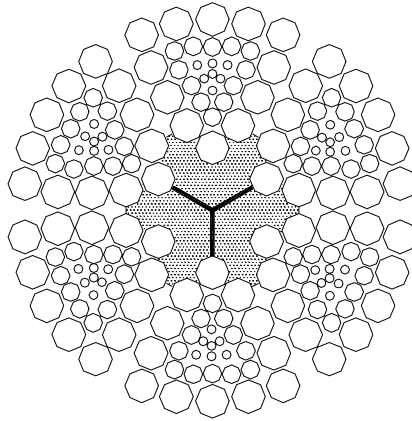

FIGURE 44. Type IV, miscellaneous, class 3, flattened strand, construction 4, 6 by 31, style V.

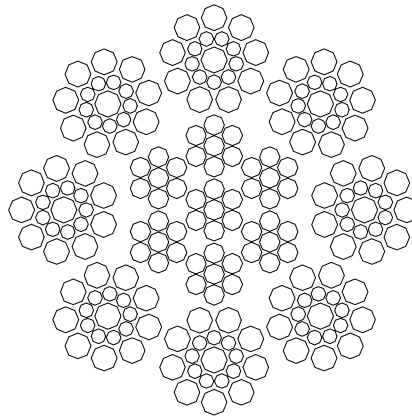

FIGURE 45. Type IV, miscellaneous, class 4, construction 1, 8 by 19 rotation resistant (Seale).

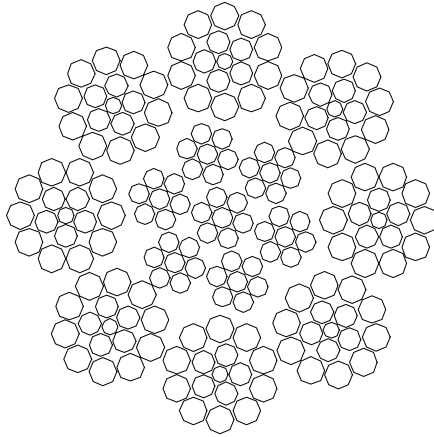

FIGURE 46. Type IV, miscellaneous, class 4, construction 2,
8 by 19 rotation resistant (Filler wire).

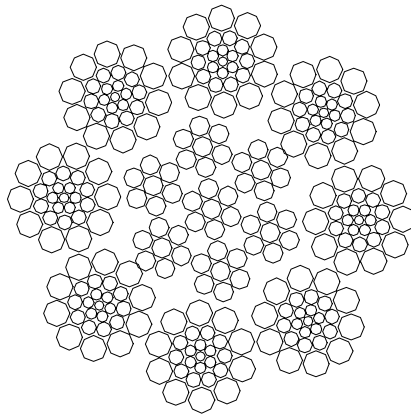

FIGURE 47. Type IV, miscellaneous, class 4, construction 3,
8 by 19 rotation resistant (Warrington-Seale).

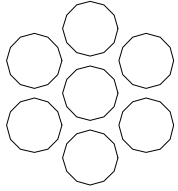

FIGURE 48. Type V, auxillary wire strands, class 1, 1 by 7 seizing strand.

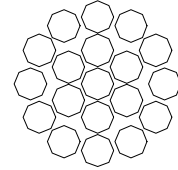

FIGURE 49. Type V, auxillary wire strands, class 2, 1 by 19 seizing strand (2 operations).

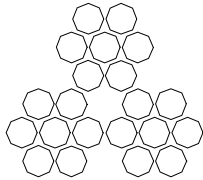

FIGURE 50. Type VI, small cords, class 1, 3 by 7.

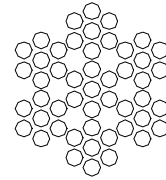

FIGURE 51. Type VI, small cords, class 2, 7 by 7.

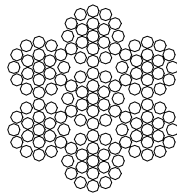
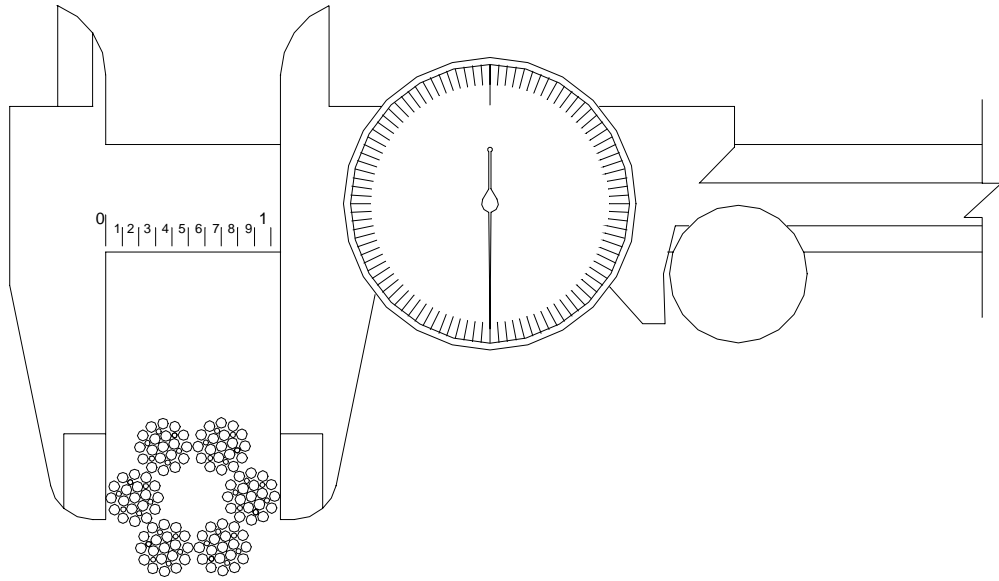
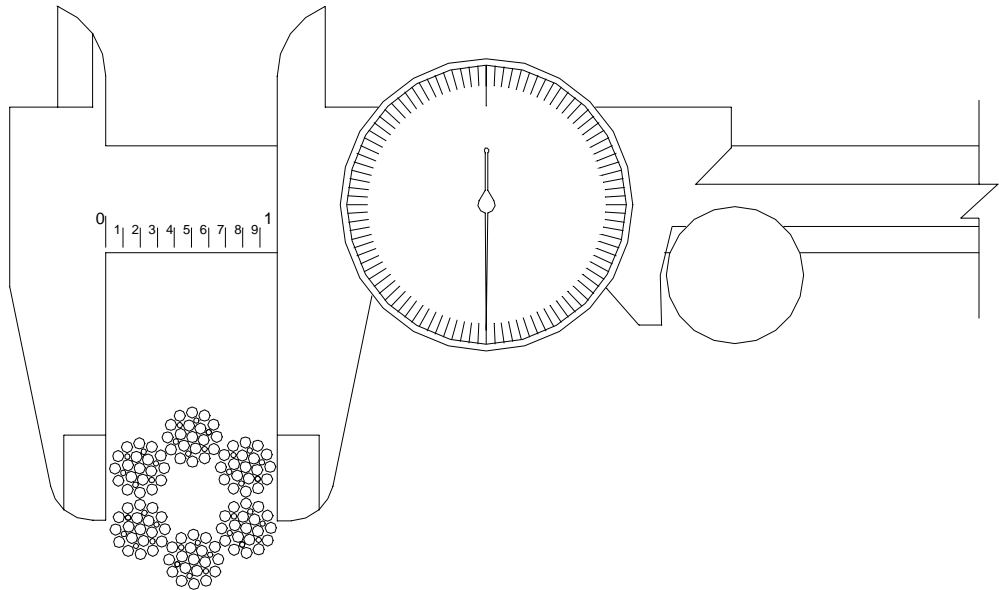

FIGURE 52. Type VI, small cord, class 3, 7 by 19 (2 operations).



CORRECT WAY
THIS GIVES CORRECT
DIAMETER



INCORRECT WAY
THIS DOES NOT GIVE
CORRECT DIAMETER

FIGURE 53. Determination of the wire rope diameter.

MILITARY INTERESTS:

Custodians:

Navy - SH

Air Force - 99

Reviewers:

Navy - YD

Air Force - 71

CIVIL AGENCY
COORDINATING ACTIVITY:

GSA - 7FXE

Preparing activity:

DLA - GS5

(Project 4010-0106)

STANDARDIZATION DOCUMENT IMPROVEMENT PROPOSAL

INSTRUCTIONS

1. The preparing activity must complete blocks 1, 2, 3, and 8. In block 1, both the document number and revision letter should be given.
2. The submitter of this form must complete blocks 4, 5, 6, and 7.
3. The preparing activity must provide a reply within 30 days from receipt of the form.

NOTE: This form may not be used to request copies of documents, nor to request waivers, or clarification of requirements on current contracts. Comments submitted on this form do not constitute or imply authorization to waive any portion of the referenced document(s) or to amend contractual requirements.

I RECOMMEND A CHANGE:	1. DOCUMENT NUMBER RR-W-410E	2. DOCUMENT DATE (YYYYMMDD) 7 FEBRUARY 2002
3. DOCUMENT TITLE WIRE ROPE AND STRAND		
4. NATURE OF CHANGE (<i>Identify paragraph number and include proposed rewrite, if possible. Attach extra sheets as needed.</i>)		
5. REASON FOR RECOMMENDATION		
6. SUBMITTER		
a. NAME (<i>Last, First, Middle Initial</i>)	b. ORGANIZATION	
c. ADDRESS (<i>Include Zip Code</i>)	d. TELEPHONE (<i>Include Area Code</i>) (1) Commercial (2) DSN (<i>if applicable</i>)	7. DATE SUBMITTED (YYYYMMDD)
8. PREPARING ACTIVITY		
a. NAME Defense Supply Center Richmond	b. TELEPHONE (<i>Include Area Code</i>) Commercial: (804) 279-5019 DSN: 695-5019	
c. ADDRESS (<i>Include Zip Code</i>) ATTN: DSCR-VBD (C. Hammond) 8000 Jefferson Davis Highway Richmond, VA 23297-5610	IF YOU DO NOT RECEIVE A REPLY WITHIN 45 DAYS, CONTACT: DEFENSE STANDARDIZATION PROGRAM OFFICE (DLSC-LM) 8725 John J. Kingman Road, Suite 2533 Fort Belvoir, Virginia 22060-6221 Commercial: (703) 767-6888 DSN: 427-6888	